

Carrier IN

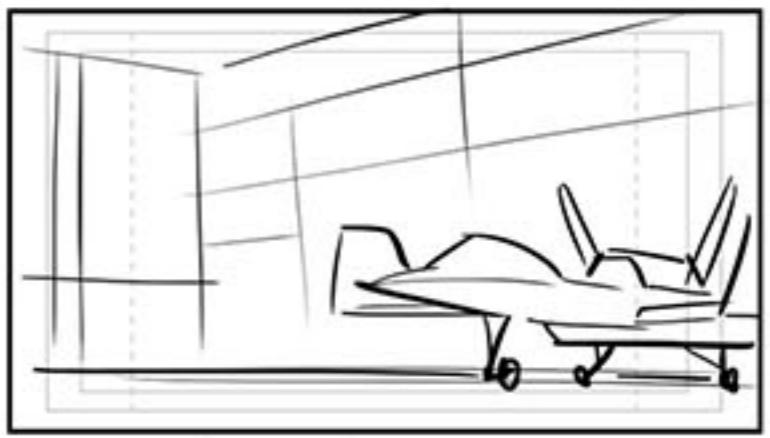

PAUSE - THOOM! THEN:  
362 IRON MAN (O.S.)  
Ummm.... Okay. Let's try this again.

Cut to int. hangar

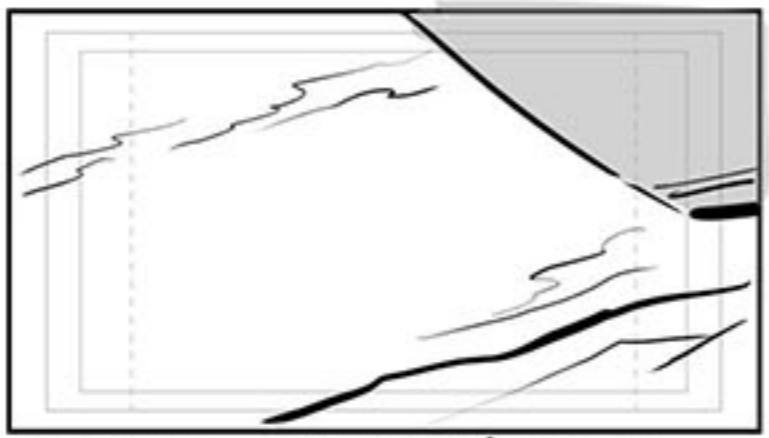
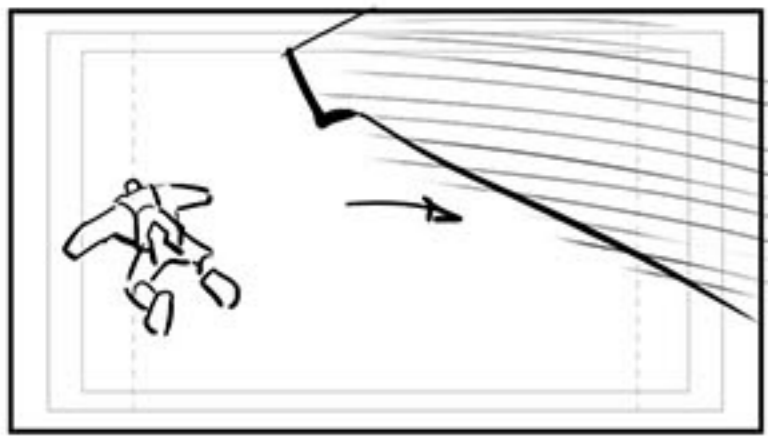
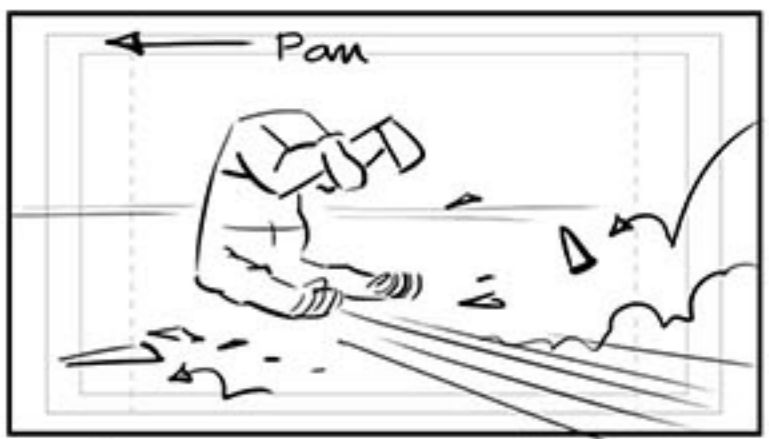
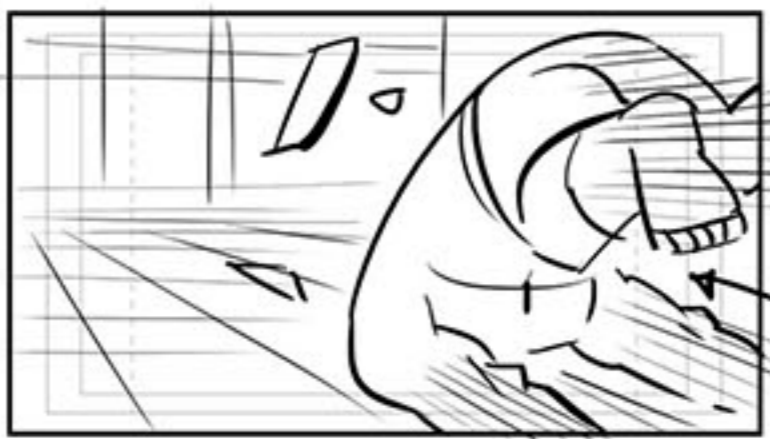

Hulk skids on his face

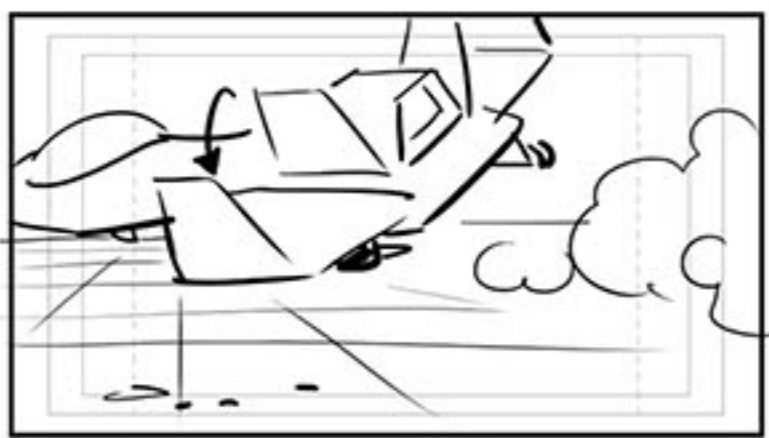

He bangs into another jet - breaks its rear wheel BAM

It tips over onto him KRUMP!

363 IRON MAN  
Close enough.

364 IRON MAN  
I guess fifth time's the charm,

Pan eh Jolly Green?



365 HULK (Grunts). If yer gonna keep yappin', at least tell me where ta go.

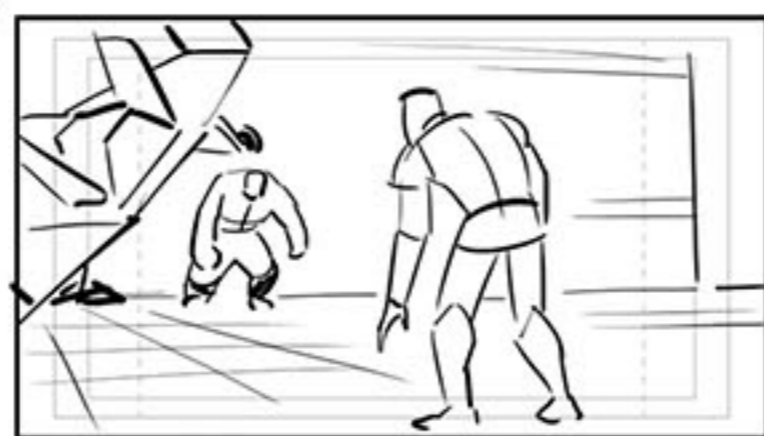

366 IRON MAN Okay, okay. About a 100 paces left.

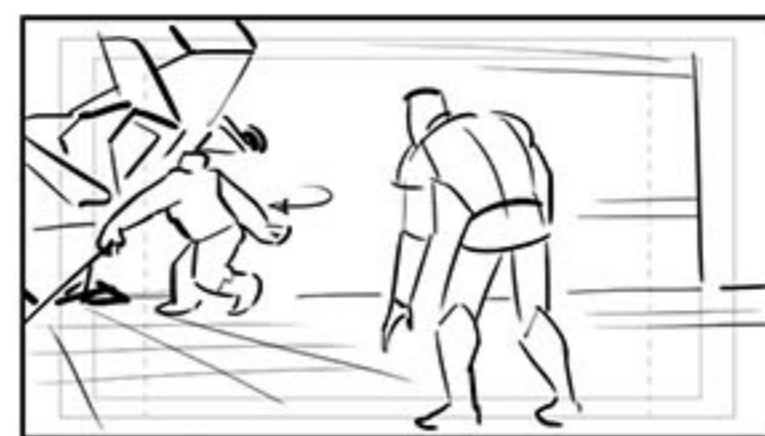

BONK!

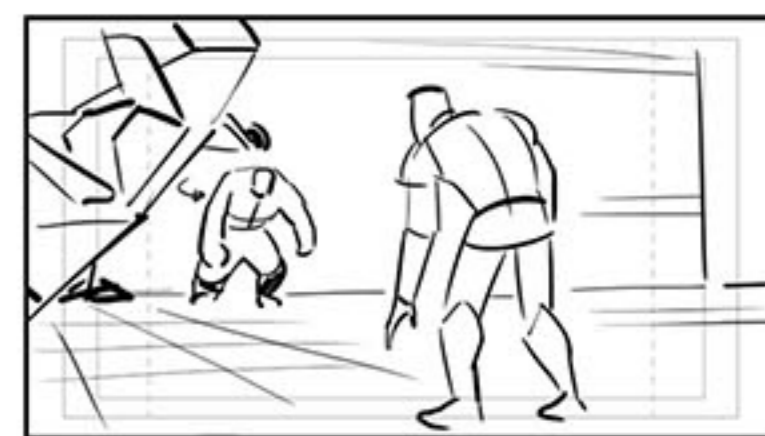

367 IRON MAN Your other left, genius.

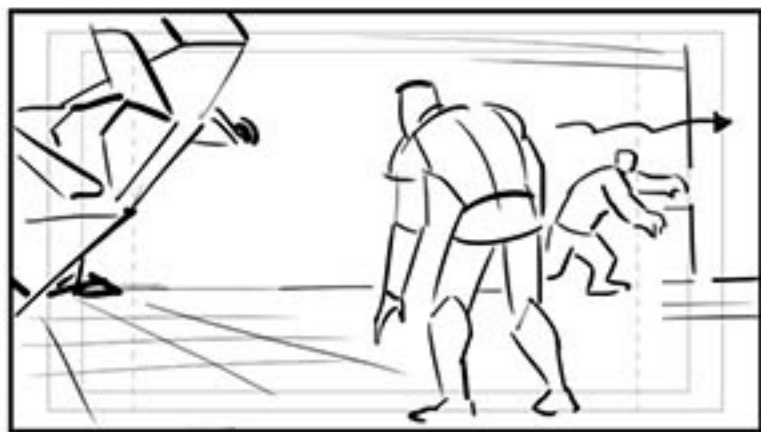

368 IRON MAN And try not to make a racket.

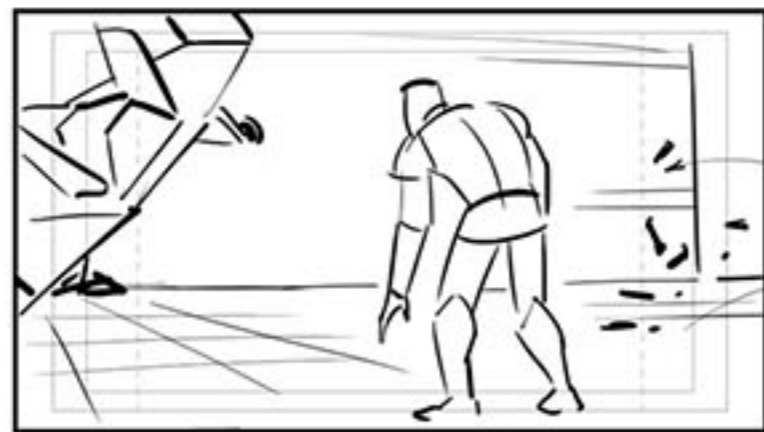

CRASH  
TINKLE-THUNK

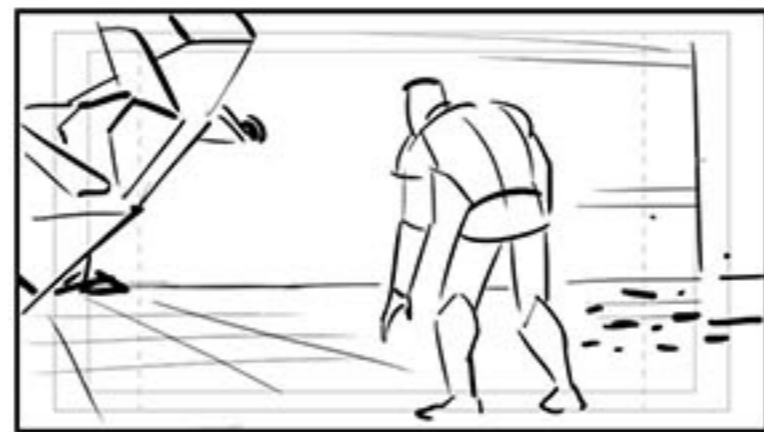

369 IRON MAN Nice. You're about as stealthy as a T-Rex.

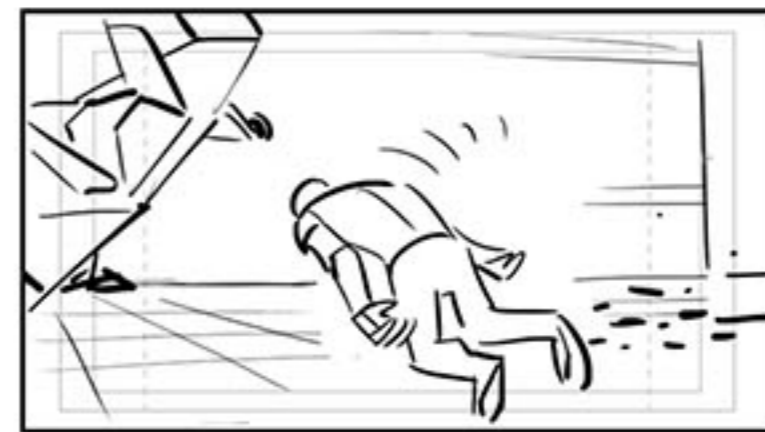

Creeeak ...

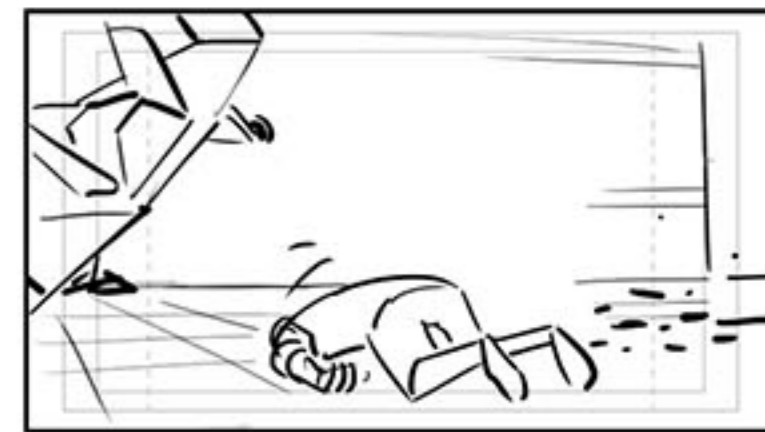

GLUNK

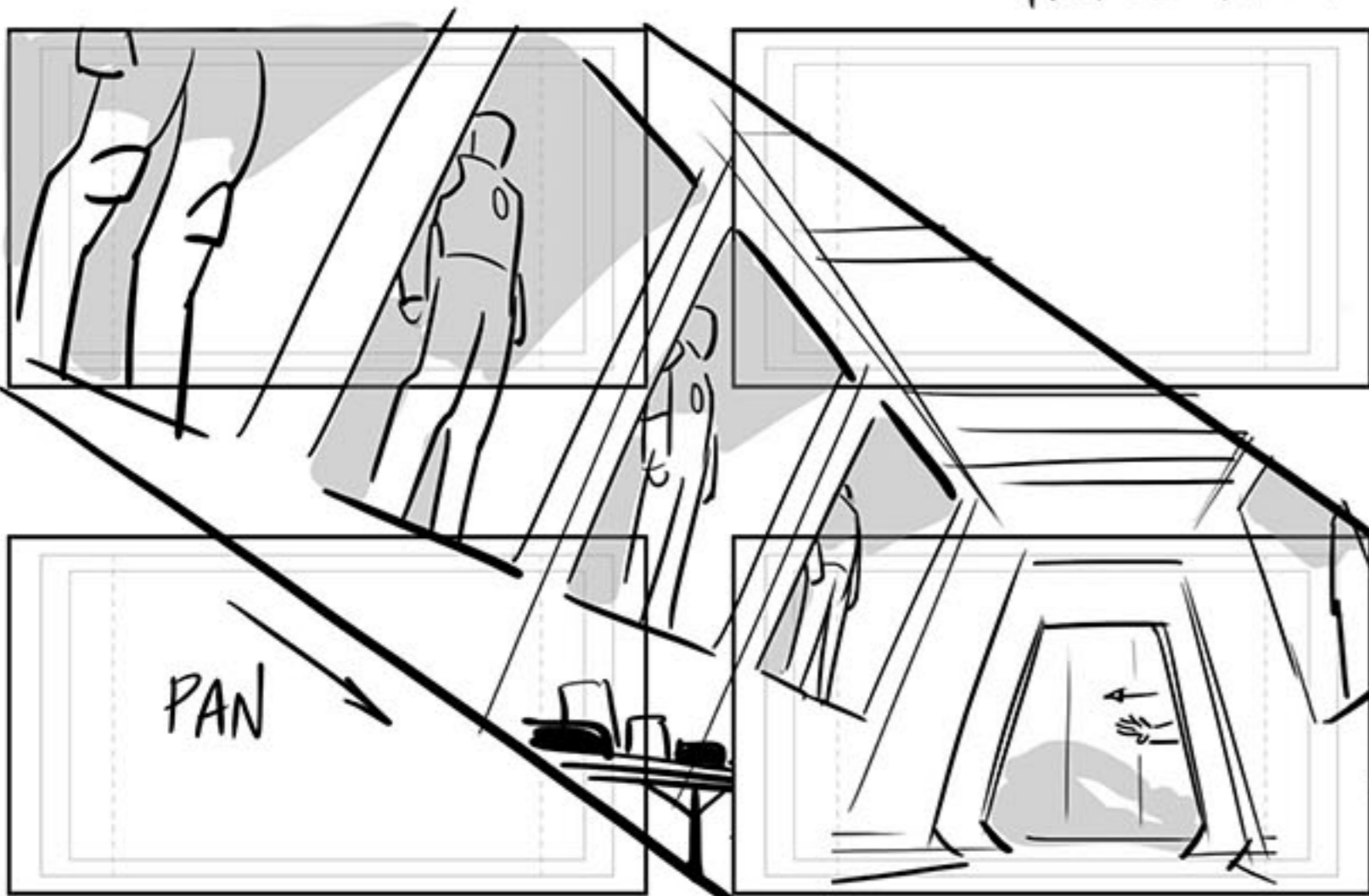

HORRIBLE SCRAPING SFX...



Hulk feels door frame



SCRAAAAPE  
(dragging IM)



370 IRON MAN It only took half the night, but we made it.



371 HULK Next time you get zapped in the face and carry me.

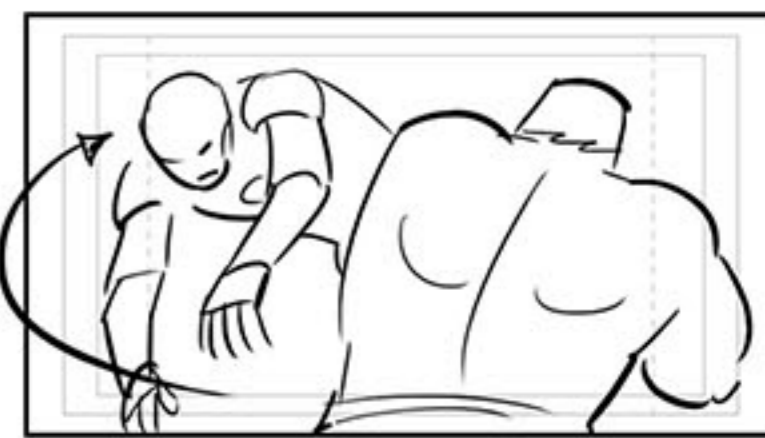
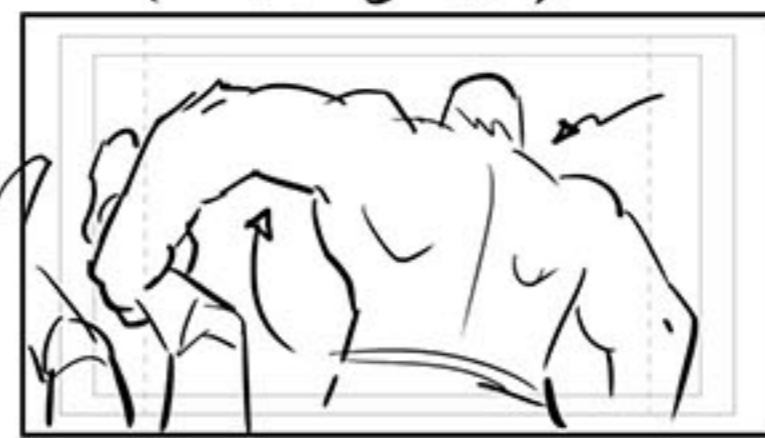

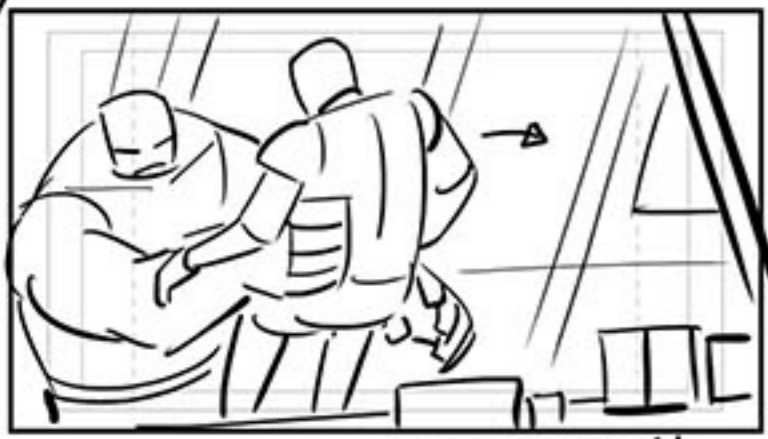

WORKBENCH

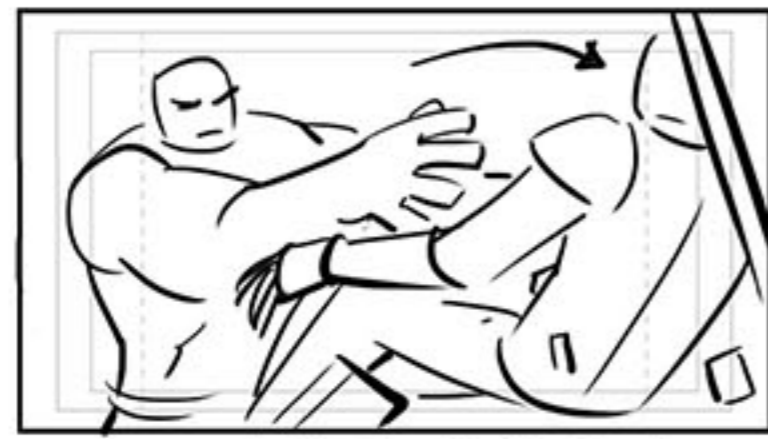

KRUNK!



He reaches OS, feels around for a beat

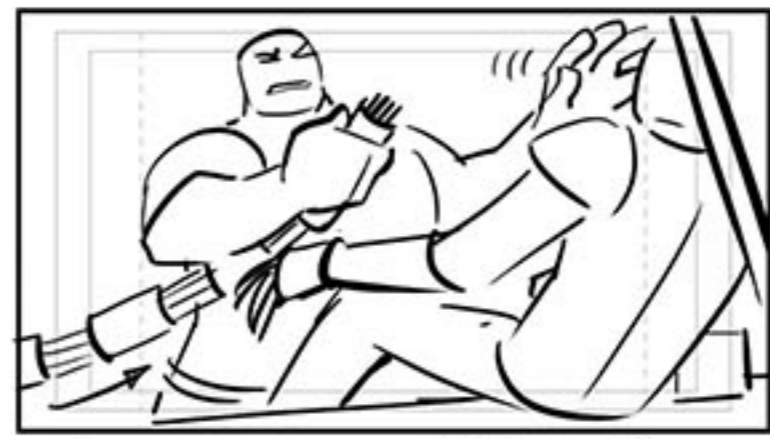

-brings up power cable

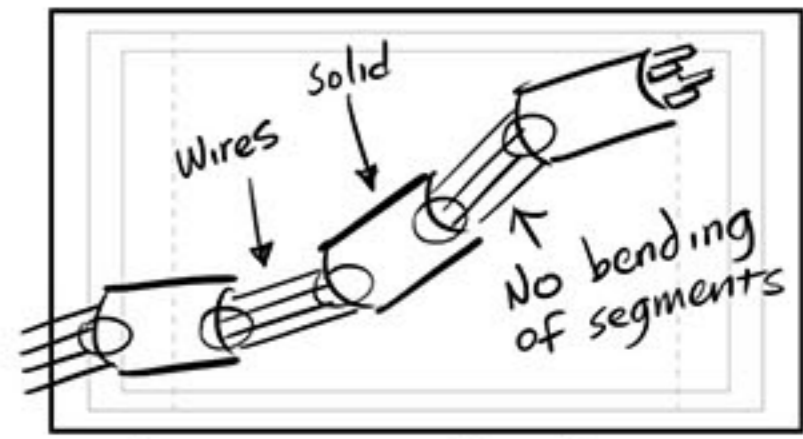

(design idea)



Clumsy patting on helmet - follow hand down to chest

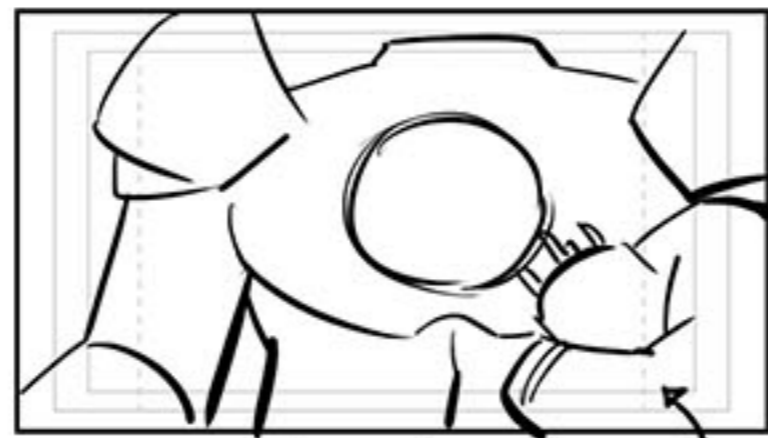

other hand in with cable



ZZT! IM-Pain Walla



ZZT! IM-Pain Walla



CLICK! POWERUP SFX



Pan up to head IM = DEEP BREATH



Truck out-body slumps with relief



372 IRON MAN I'm gonna slip into some new work clothes. Just take it easy, Hulk.

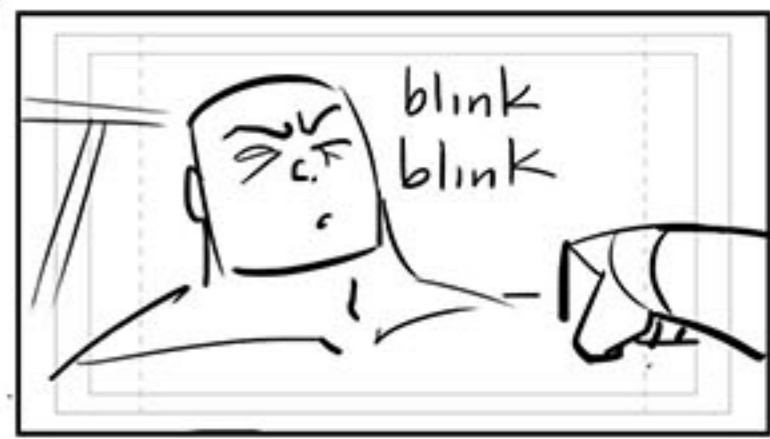

THIS LINE CAN BE CUT (REDUNDANT)

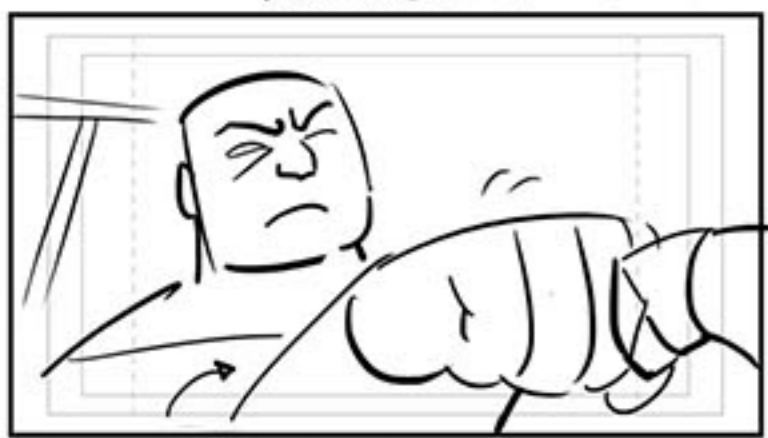

Gentle fist bump



373 HULK Stark. Can you... fix my eyes?



374 TONY (vo) I'll do my best, big guy. Just give me 30 seconds to armor up.

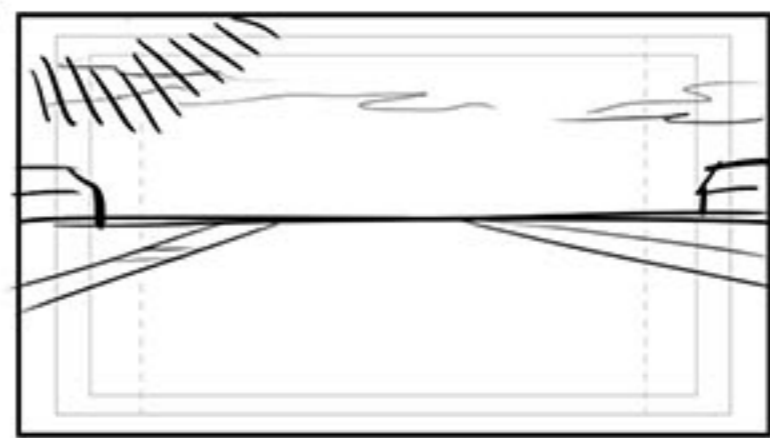

flashes on top deck cut to deck - flashes from OS

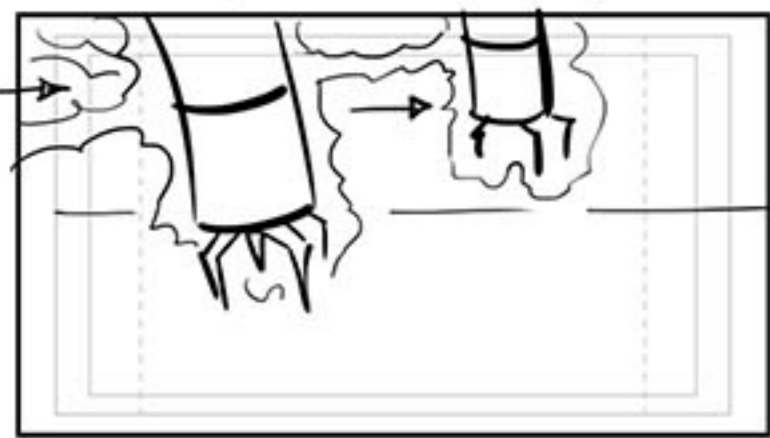

z moves cables into scene



Stab into deck



Z energy flows down cables - 3 more in



Repeat action



On Z, hovering

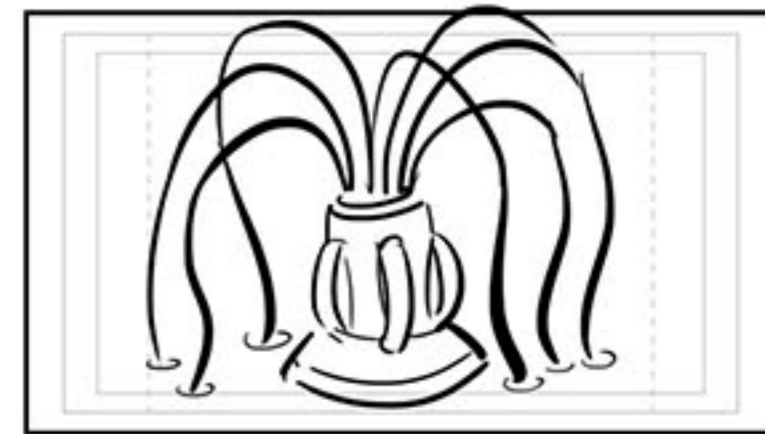

Model note - reuse machinery from generator set - take top off, fill with cables



Lift 2nd machine thru scene

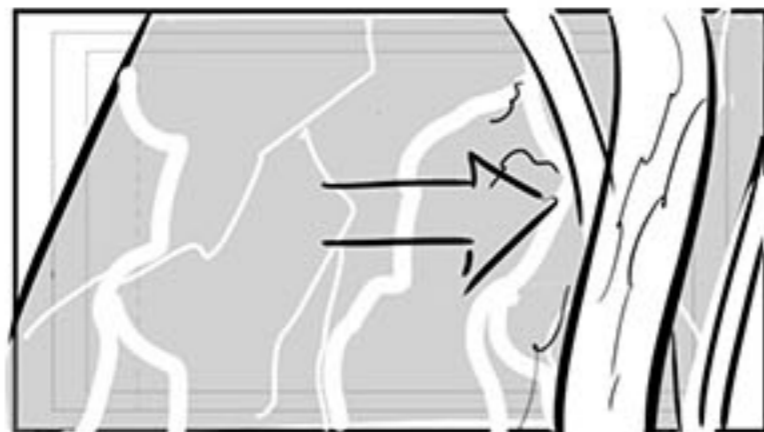

Pull cables out - they rise

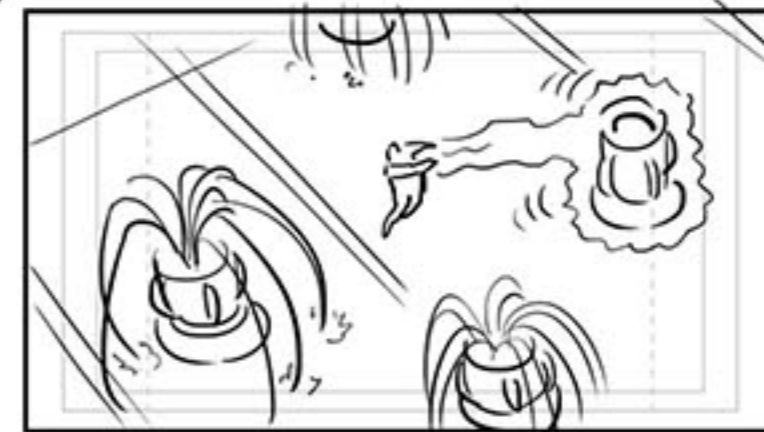

Wide - 3 condensers already set up - 4th moved into place

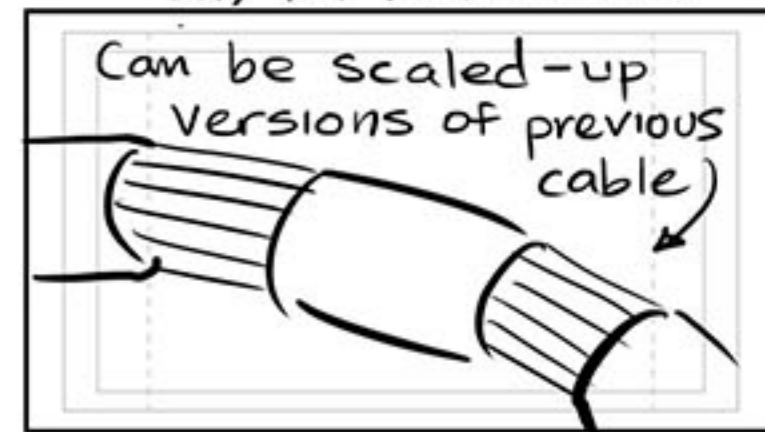

Can be scaled-up versions of previous cable

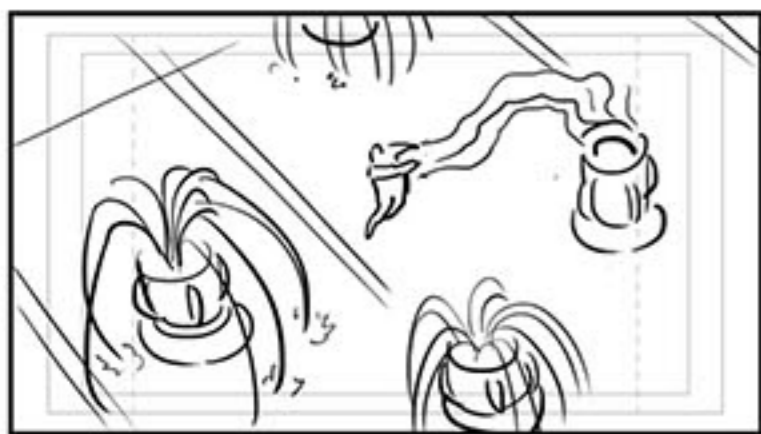

START PAN DOWN



TILT UP

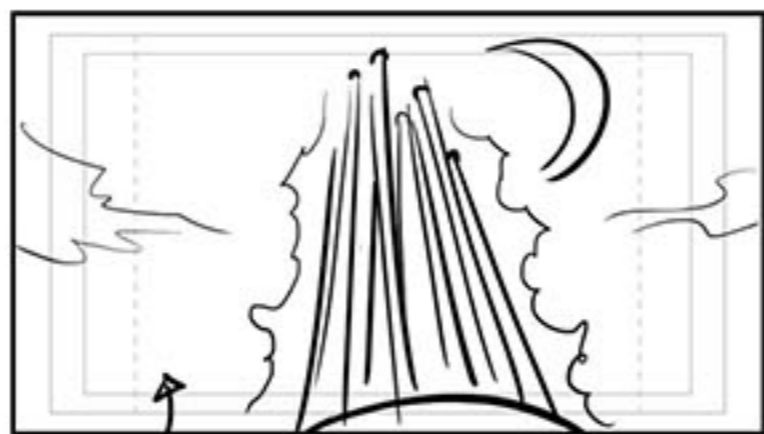

Strike deck



Wide on carrier - energy blasts down



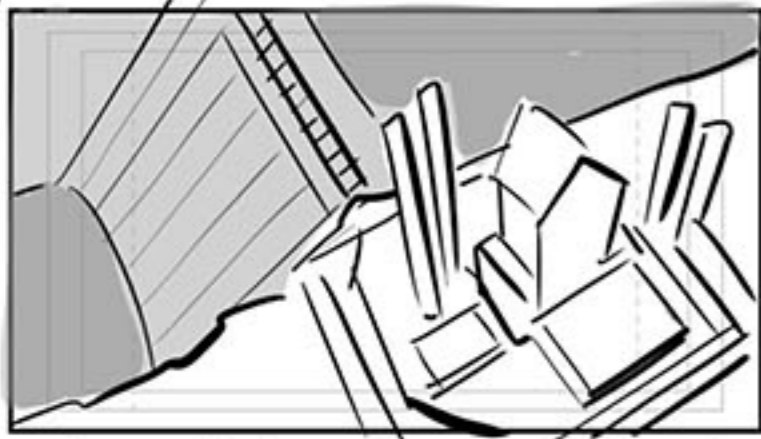

Downshot on power plant & dam



Energy in



Wide on carrier hovering over power plant



Interior



Cut to platform with wrecked equipment



Lightning grabs shards of arc reactor



↑ ↑ ↑

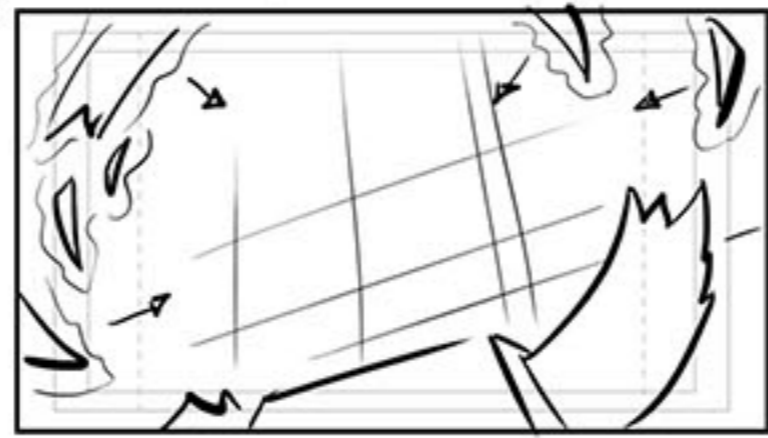

↘ ↙ ↗ ↖

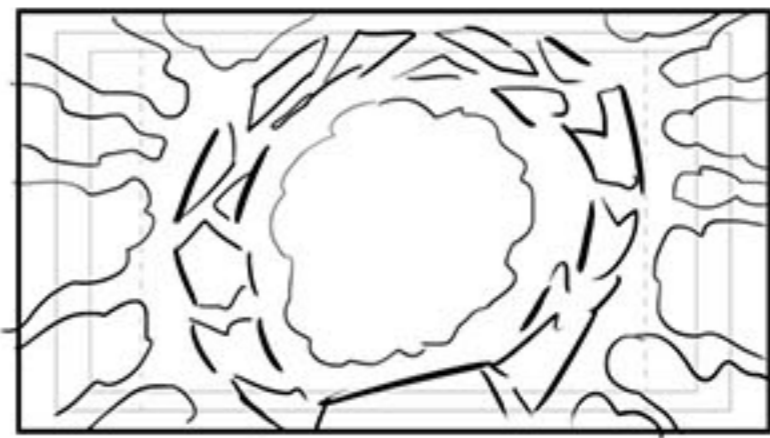

Truck out as pieces come together

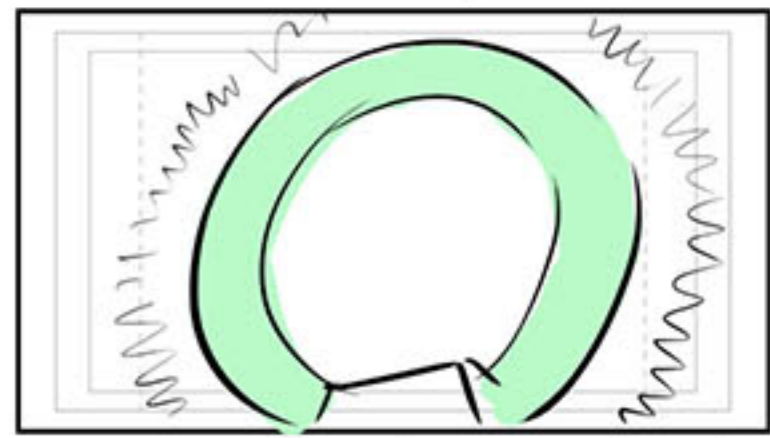

It instantly reactivates



back to wide shot- FX increase



light blows out scene to white

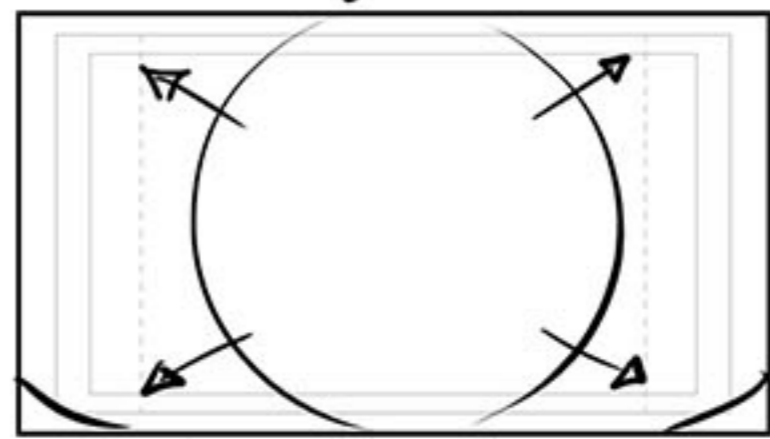

Truck out of new reactor on IM's chest



Can't out to med. shot  
375 IRON MAN  
The Mark 7 armor!

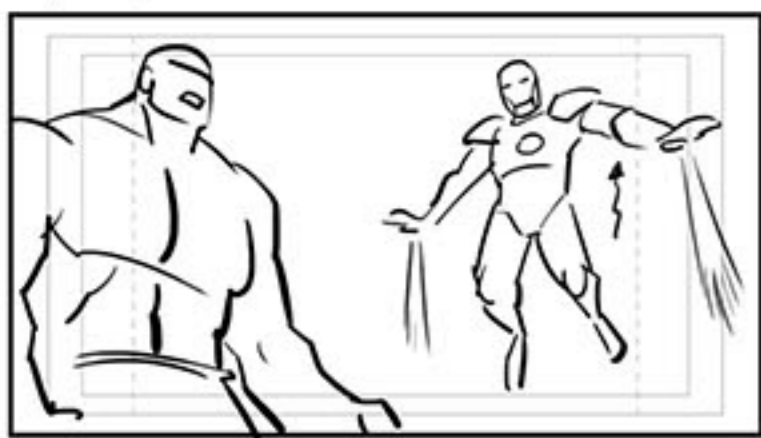

What do you think Hulk?



376 HULK  
Did you forget I can't see?

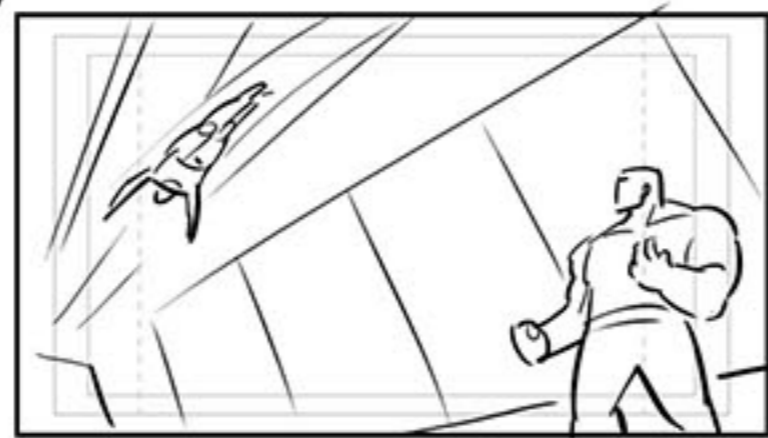

377 IRON MAN  
Well, I'm wearing a

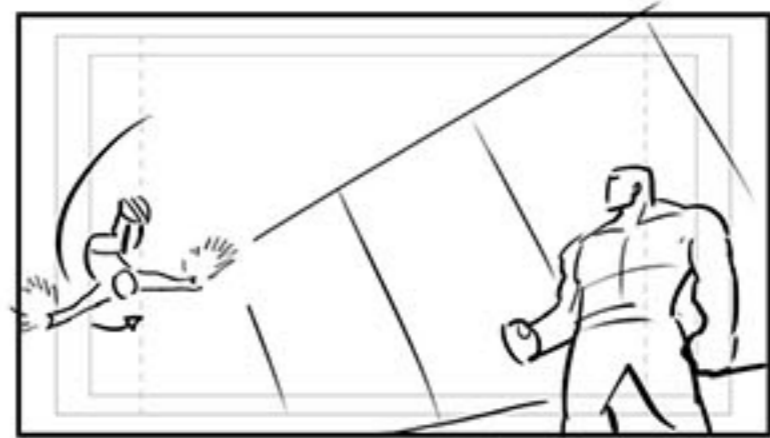

new suit. It's untested and

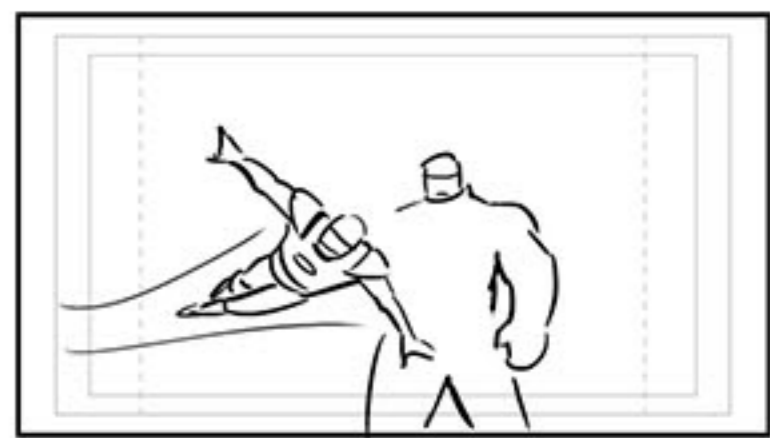

probably a little buggy,

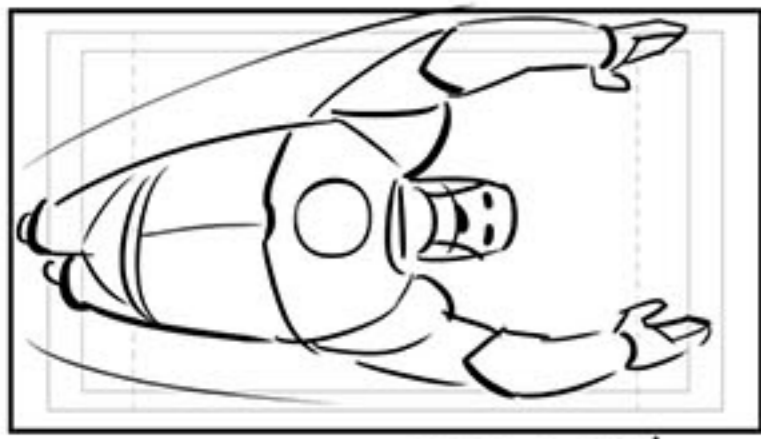

→ Pan with  
but it's got better shields to keep Zzzax out.

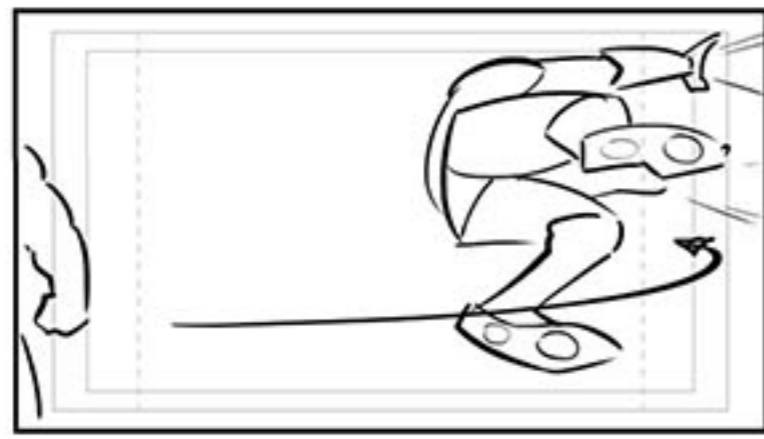

It reaches out blindly

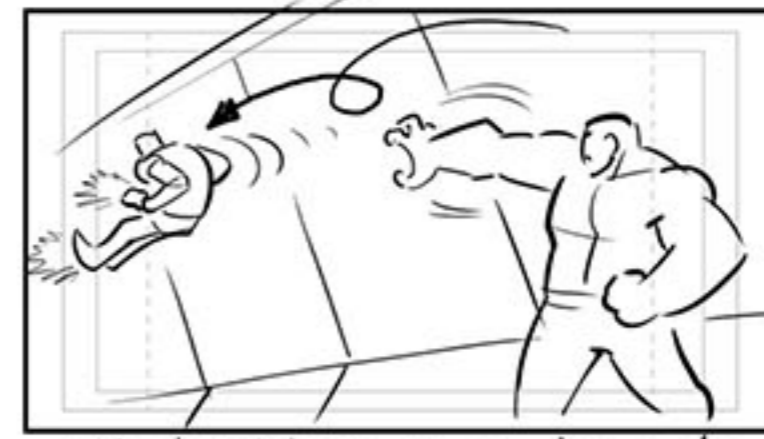

← Pan back  
Jarvis, you remodulate the repulsors?

IM tumbles in midair to a stop (feet first)



378 JARVIS (V.O.)  
All energy weapons have been tuned



Energy meters equalize to 96.2 Megahertz, which will repel the creature's frequency.



379 IRON MAN  
Alright!

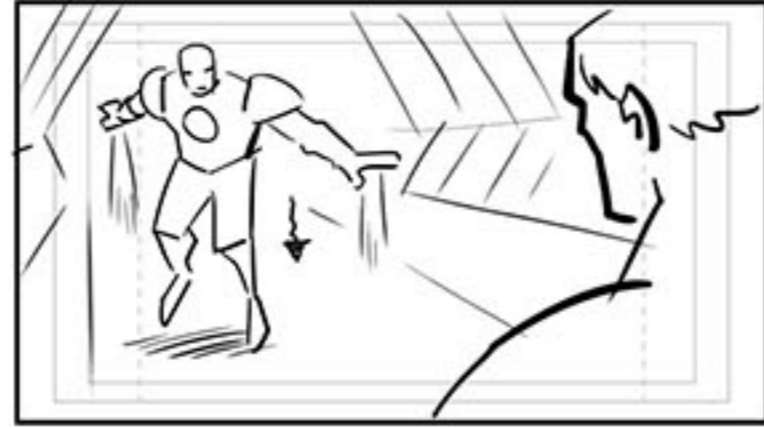

Time to fix you up, Big Green. How's the vision?



380 HULK  
Everything's still kinda blurry.



POV  
381 IRON MAN  
You're familiar with



laser eye surgery?

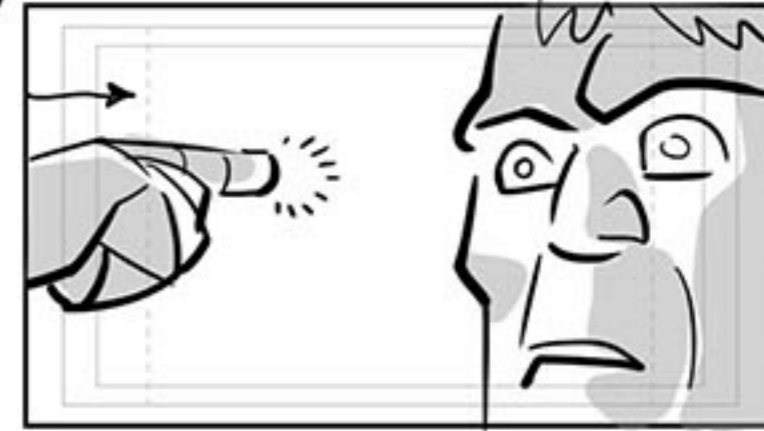

382 IRON MAN  
Now hold still... this won't hurt a bit.



(blink)  
Easy as 1, 2--



383 IRON MAN  
HEY!



SPARKS  
384 HULK  
Eyes work good enough to see



I don't need a LASER zappin' 'em.



385 IRON MAN  
I'm trying to

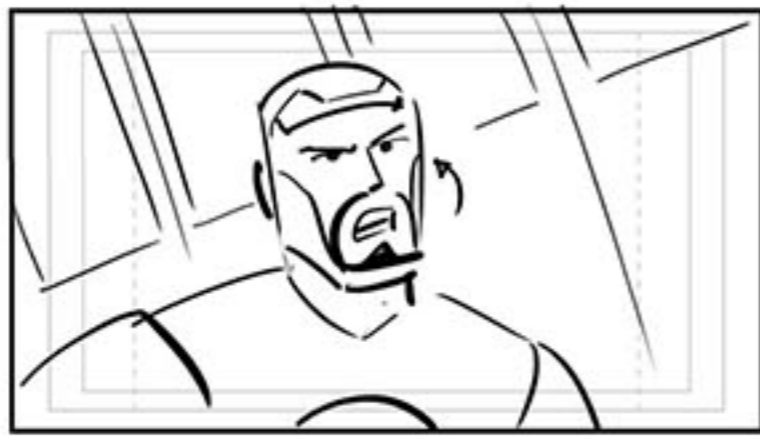

help. Look, I know



we got off on the wrong foot today,

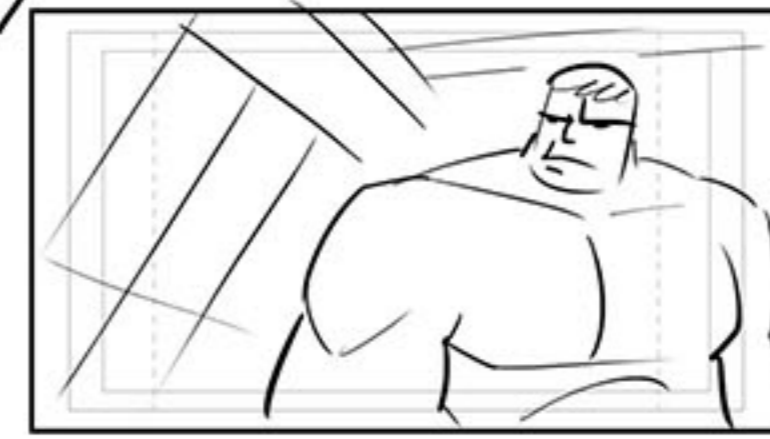

with me blasting you



and all... but we've gotta work



together on this, comprende?



This is bigger



than both of us.



386 HULK  
I know that, Stark.



Thanks... for trying to help.  
(eyes look OS)



Slight pause



387 IRON MAN  
No prob.



So here's what I figure  
is happening:



388 IRON MAN  
Zzzax is gonna use my ship



like an antenna... (pause)



(dirty look)



Point to eyes



(annoyed)



388 IRON MAN (REPEAT)  
Zzzax is gonna use my ship



like an antenna and drain all the

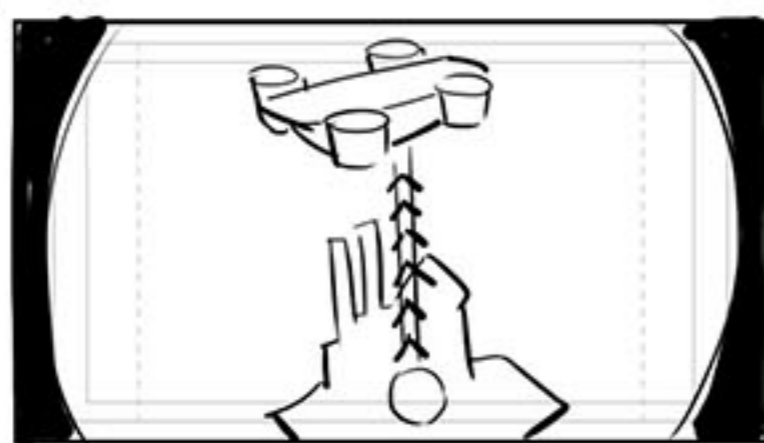

power from earth.  
(Graphics show energy flow)

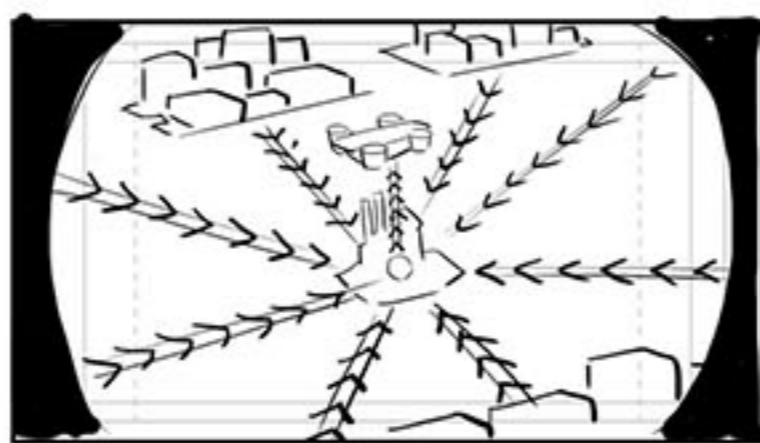

Widen - power flows from towns to plant

We can't just destroy the grid -- we'll leave millions of people in the dark.

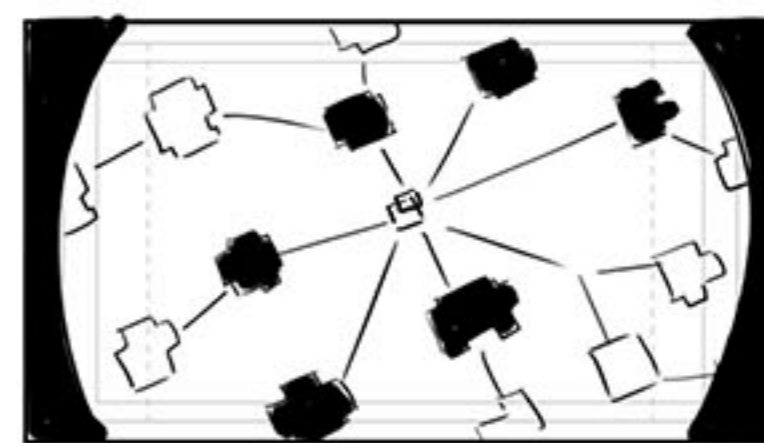

CONTINUOUS action

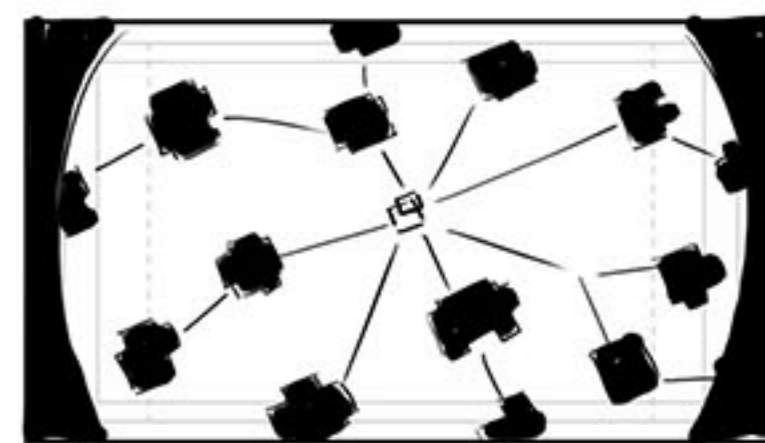

But we CAN bring Zzzax down and ground him,



if we take out my ship.

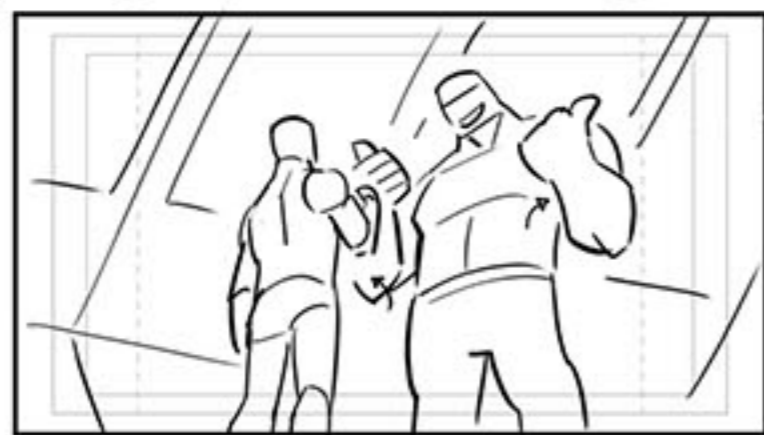

389 HULK  
Crash your iron castle, eh?



I like it.

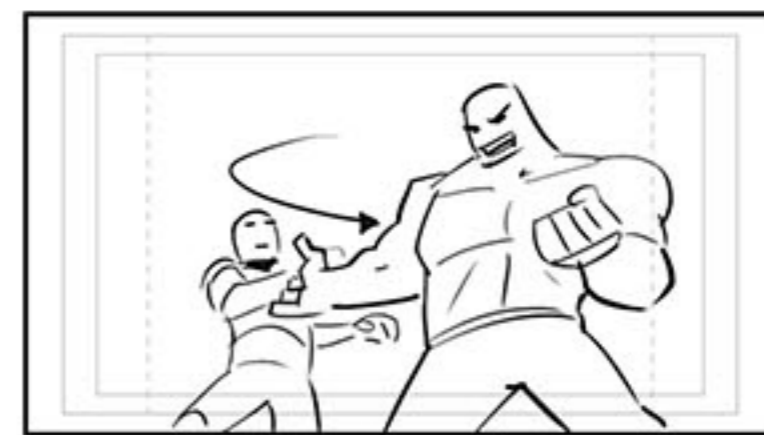

So what are we waitin' for?



Let's get SMASHIN'!



390 IRON MAN  
Hold up, Hulk!



(freeze)

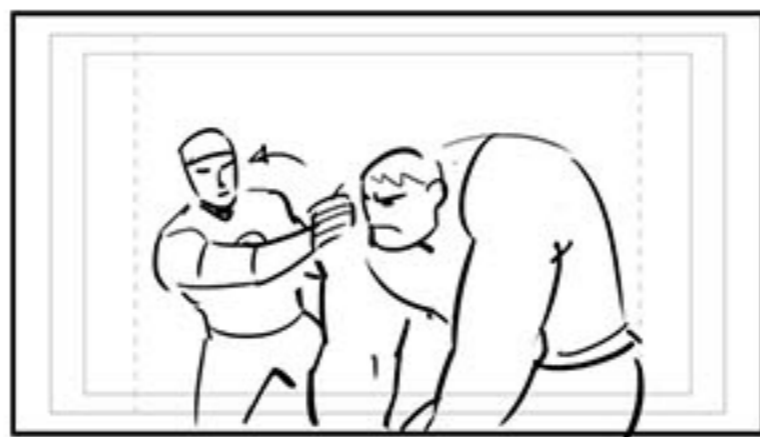

You want Sparky to zap your eyes again?



We need to insulate you somehow...



TRUCK OUT

391 HULK  
You got something Zzzax can't fry



in my size?



392 IRON MAN  
I think so...



with a little tailoring.

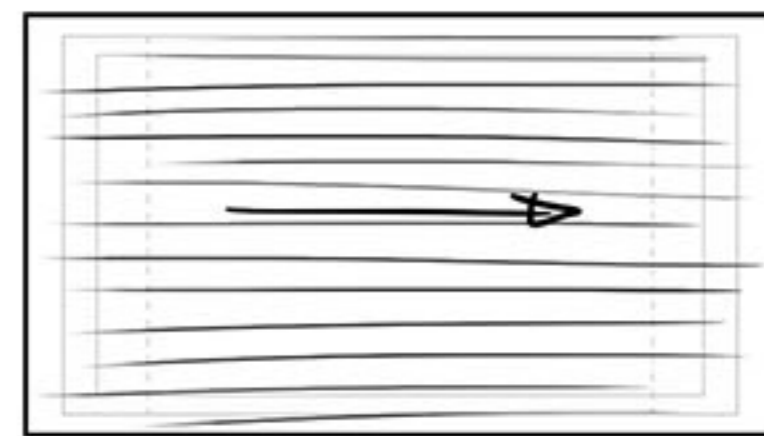

Whip Pan

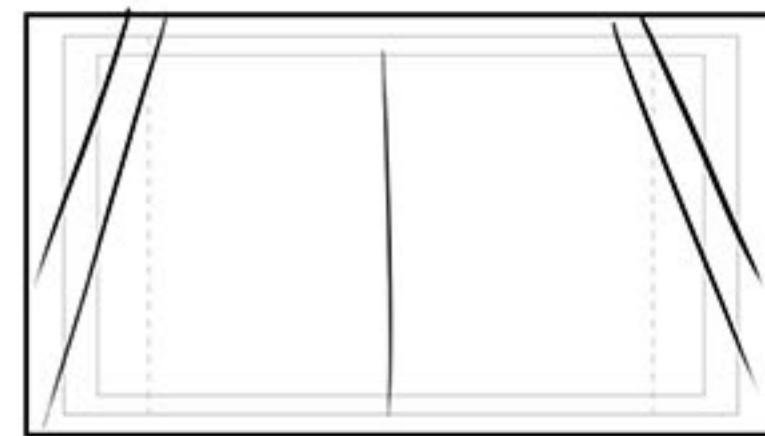

— to wall in hangar



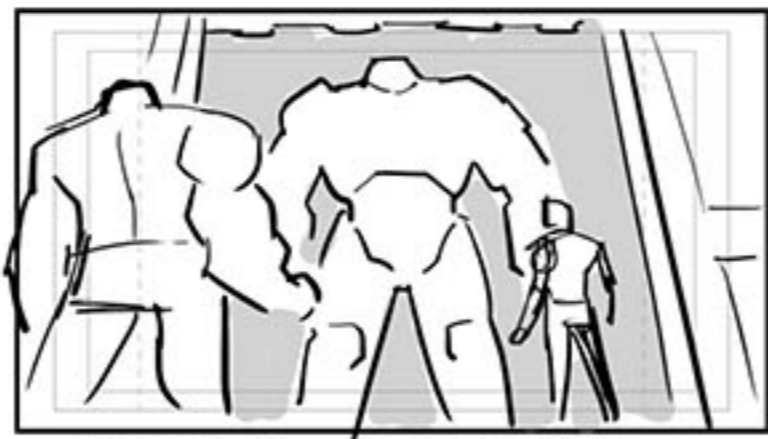
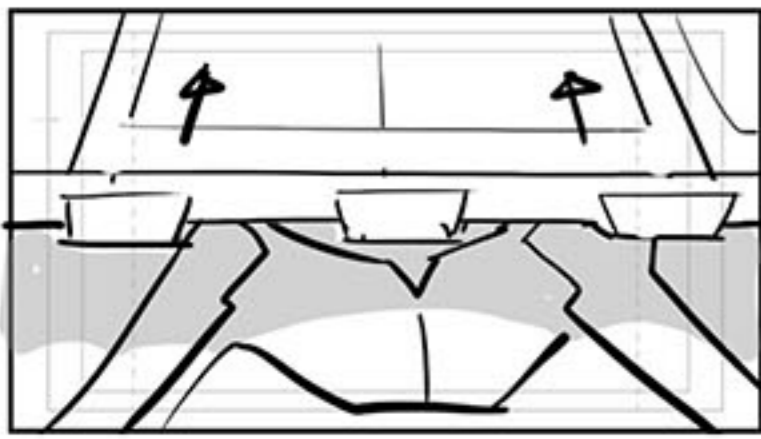

FAST PULLBACK

(cool, eh?)

(hmm...)

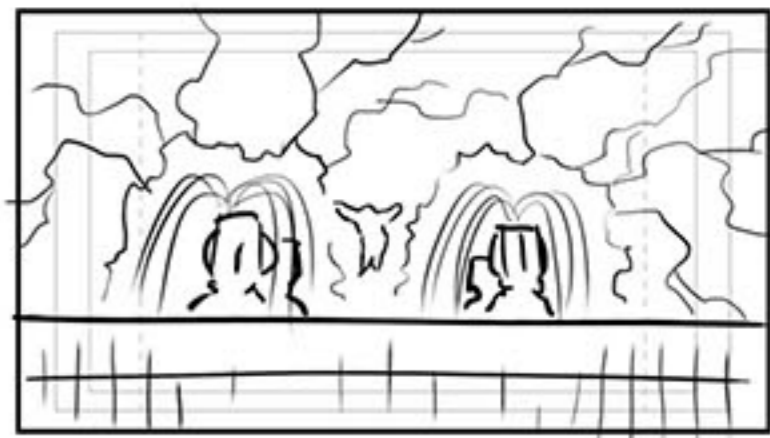
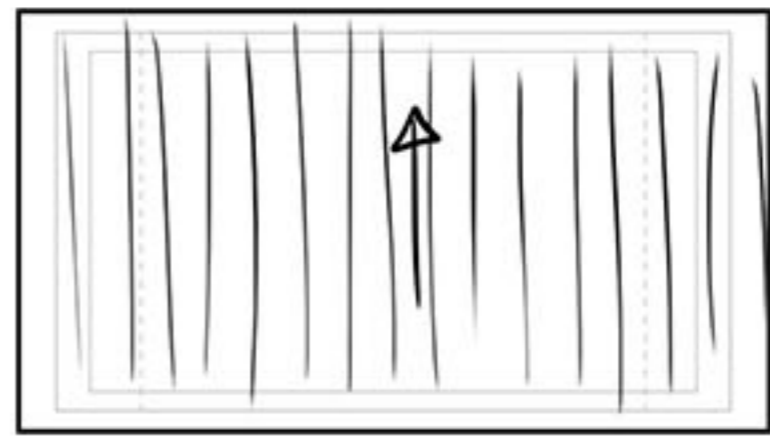

(No.)

(jerk.)

- SHAKE -

Whip pan UP

- to deck

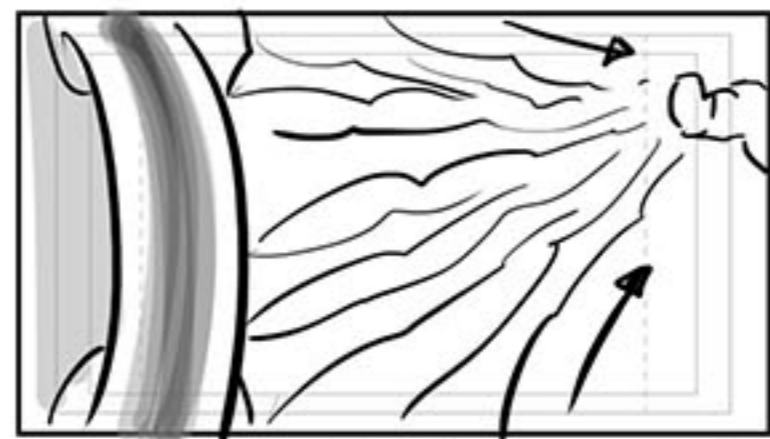
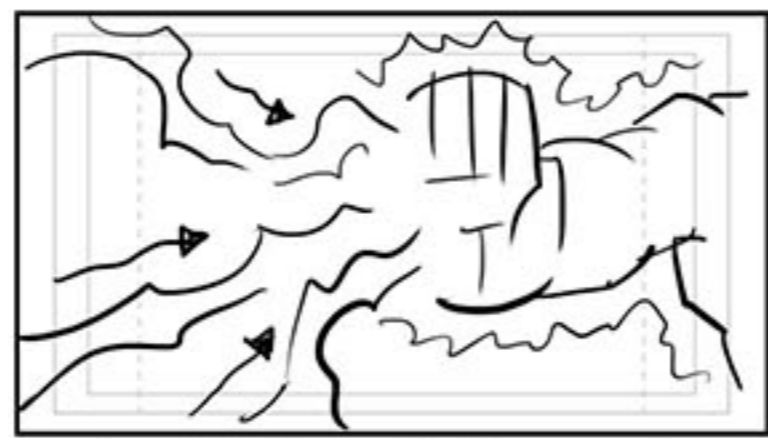
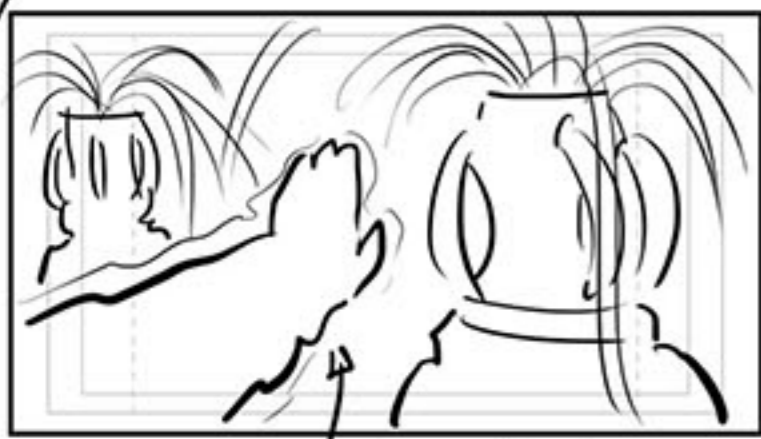

Z raises hand to converter

Pull cam back past Z - to other hand - can't back to converter

Cam cranes up to top of convertor

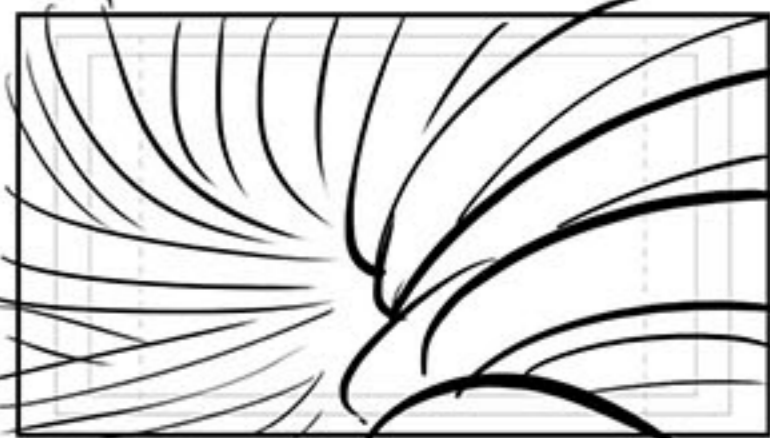
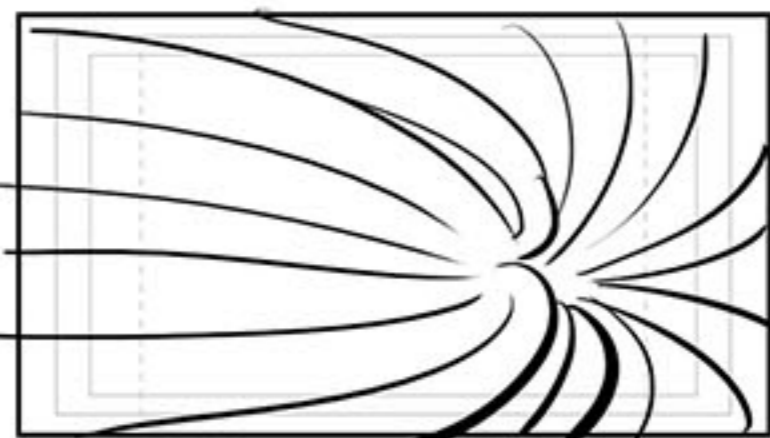
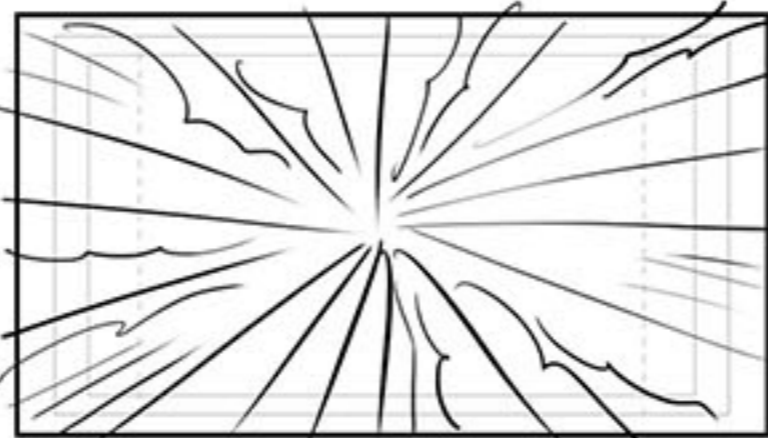
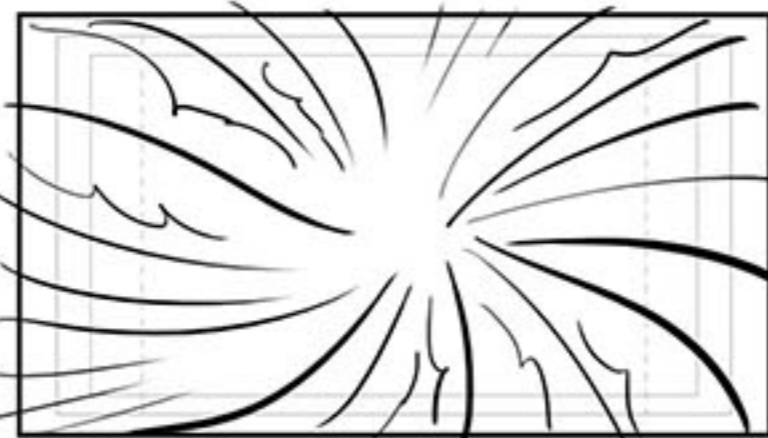

Dive into wires

Can't dive - energy races past cam & OS

Can't

Can't

Can't