

START  
ACT 1



Open on intersection



Giant foot in - tumbles the bus

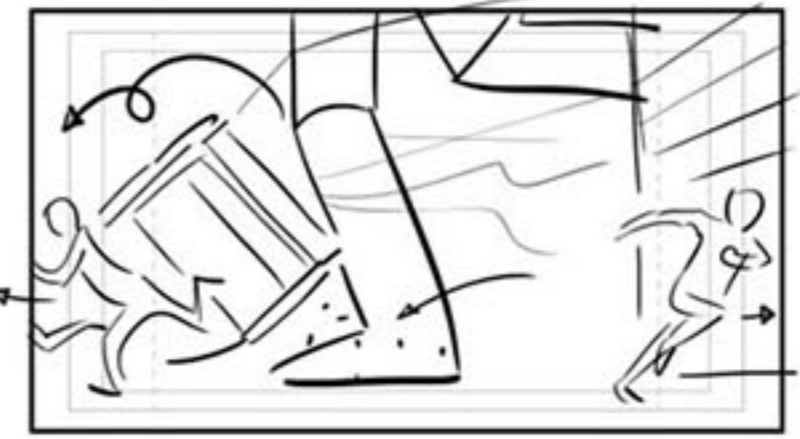

24 screams



Pan

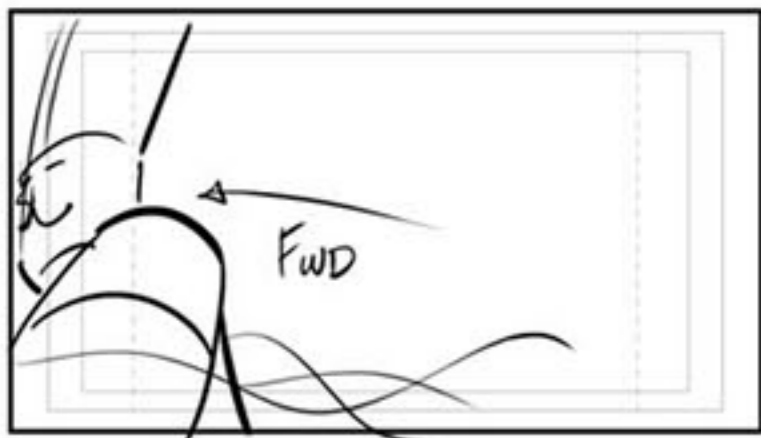

FWD



(inside cockpit)

ADD PRE-LAP LAUGHTER



25 TM: The Toyman's toys don't come cheap!



26 (VO): In fact they break — the bank!



(STOP)

the bank!



-laugh-



Pan



Work some thumb controls -



Pull back



On robot arm



Pull up vault

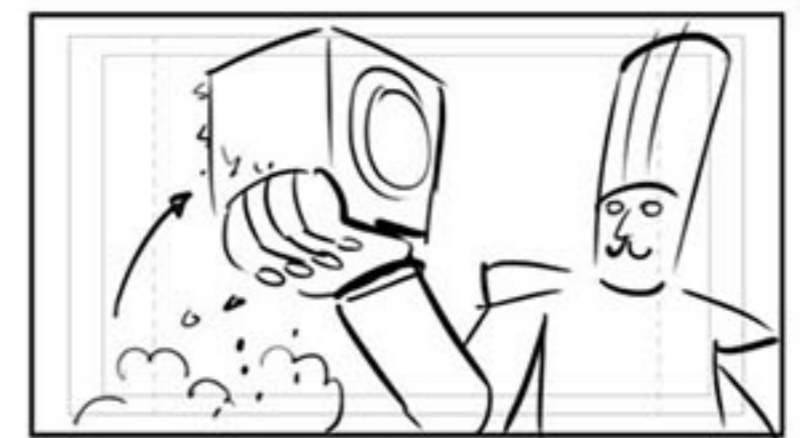
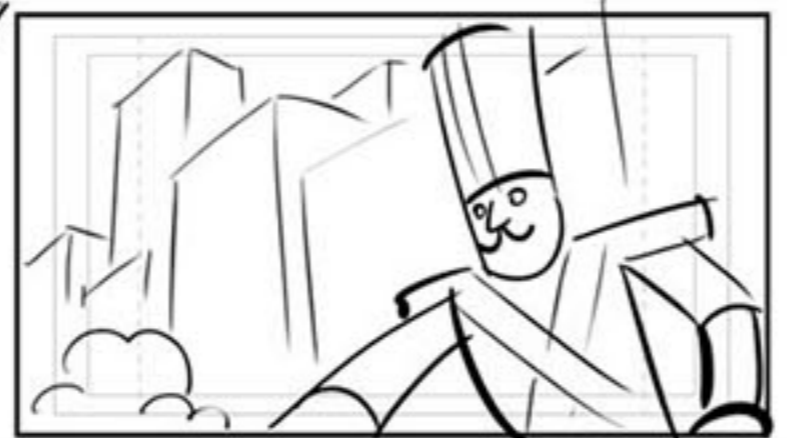

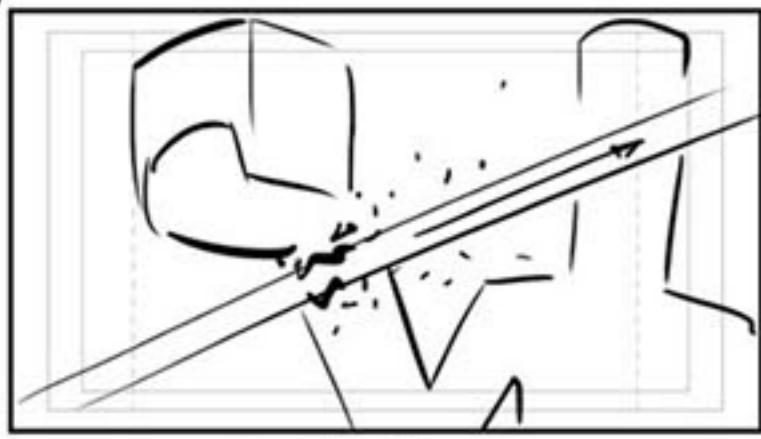

Blue streak thru



(27) TM: No! NO!



(28) screams

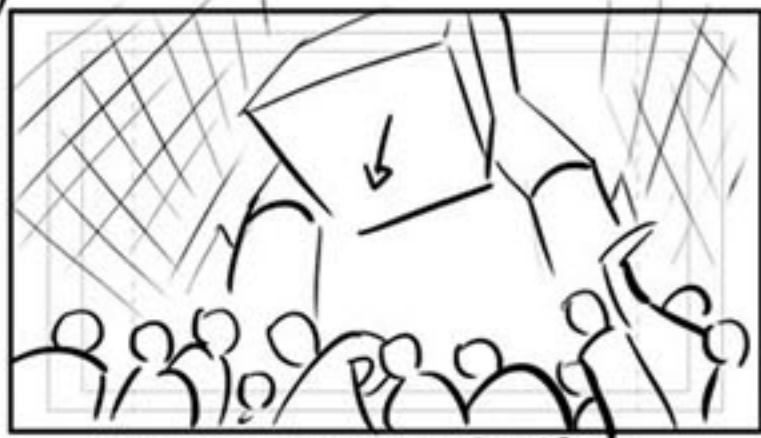
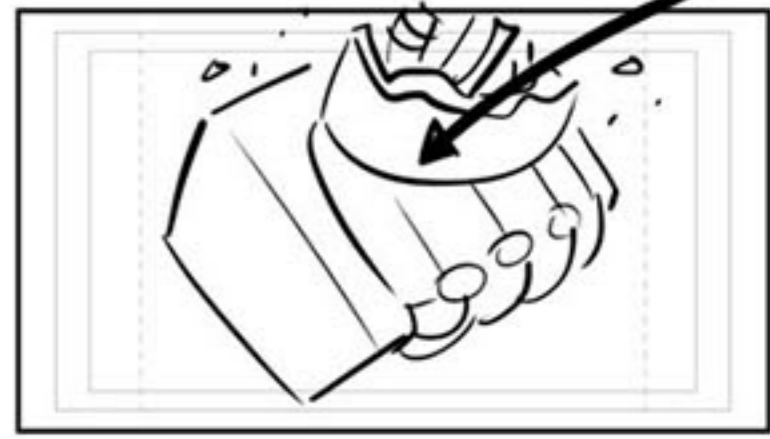

PEOPLE JAMMED TOGETHER

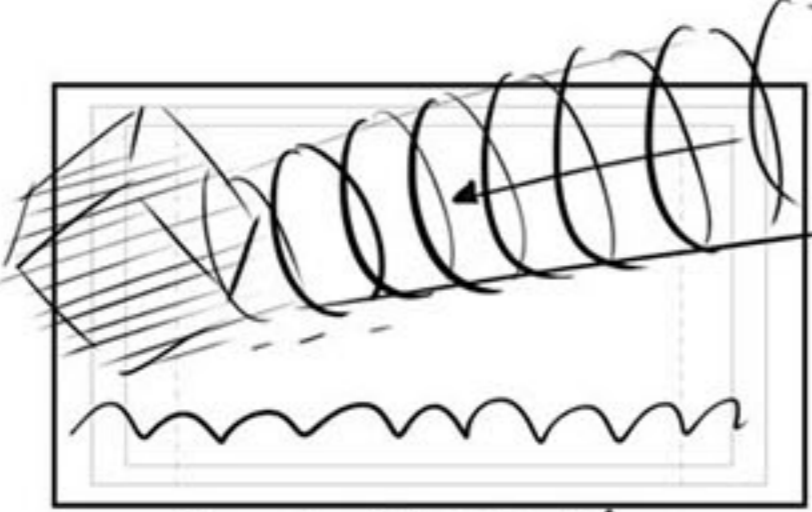

Sonic blast IN - pushes vault OS

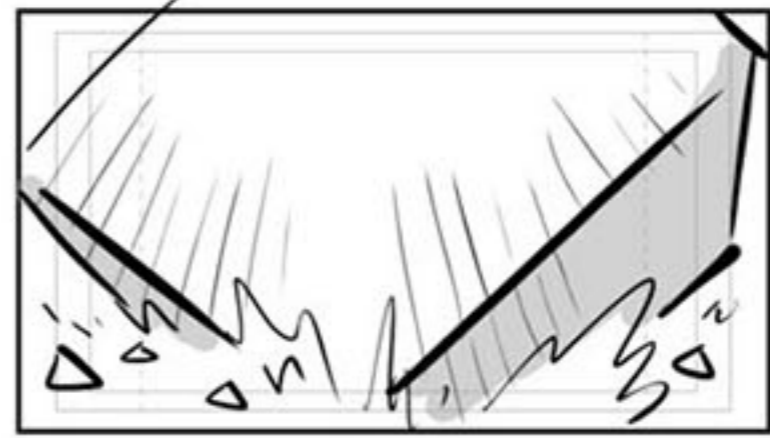

- SHAKE -

(29) SCREAMS TO GASPS

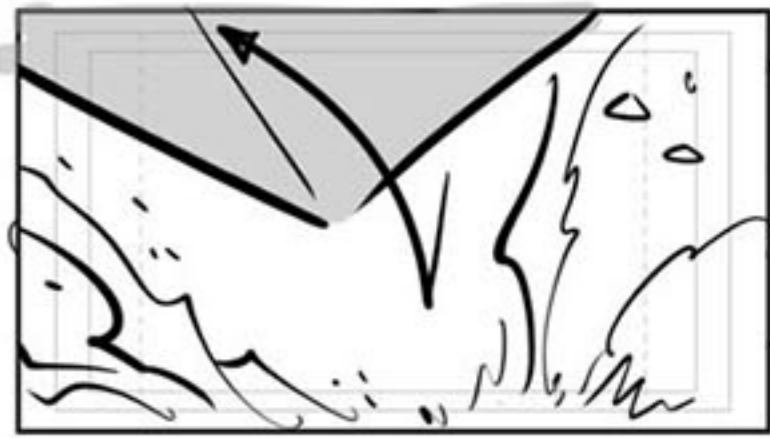

BB (IN)



(30) Crowd walk



Pan



TRUCK OUT



(31) TM: No fair! I get the hero who took down the Warworld single-handed?

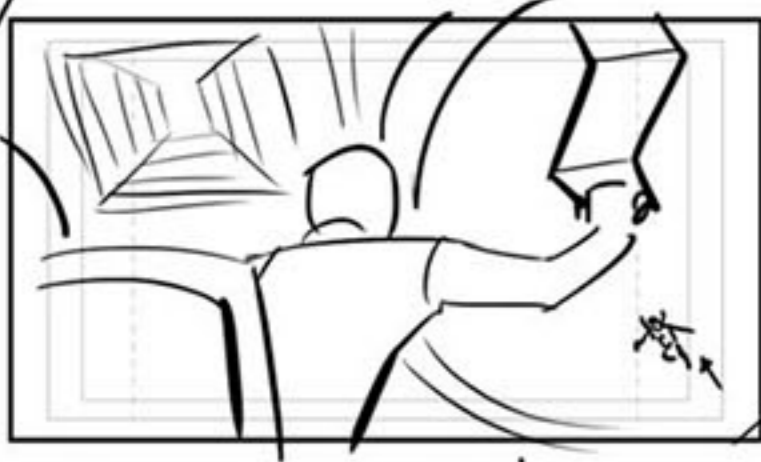

This is Metropolis!



Where's Superman?

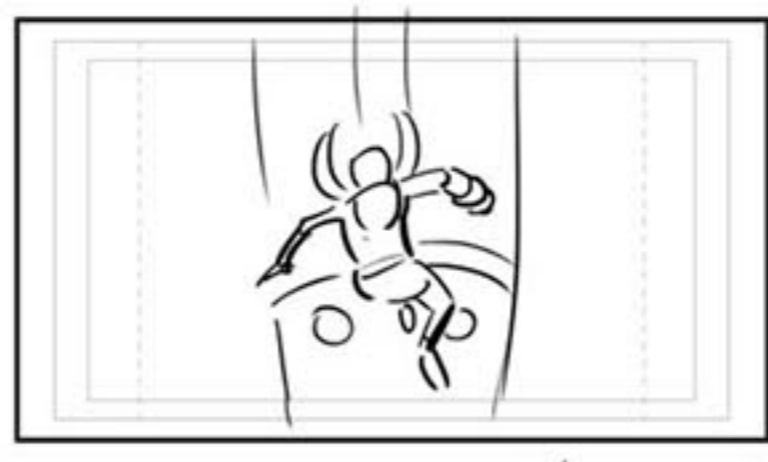

(SHAKE) as tin soldier rises up on rockets

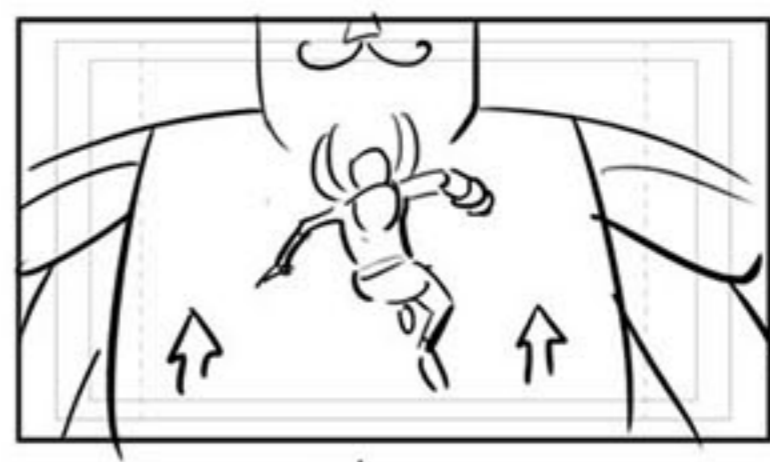

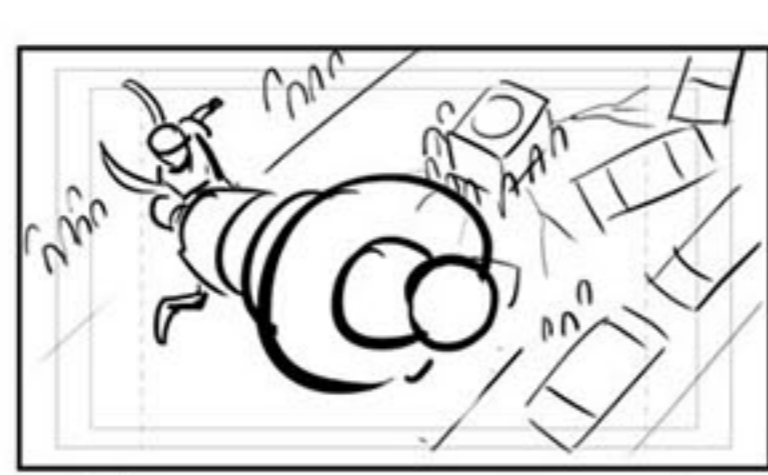
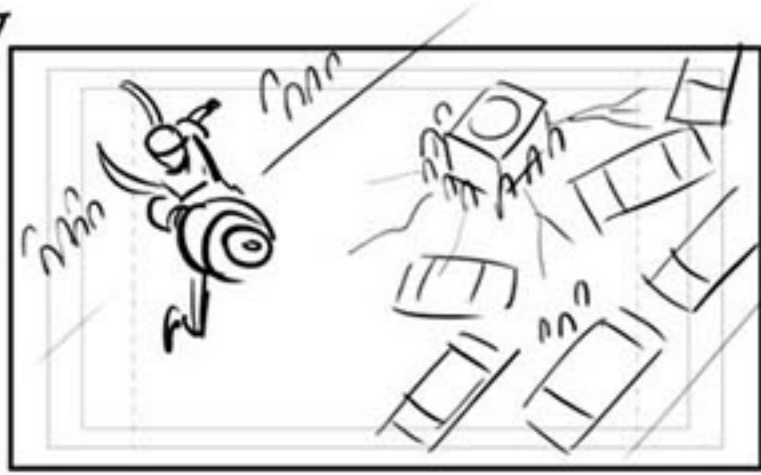
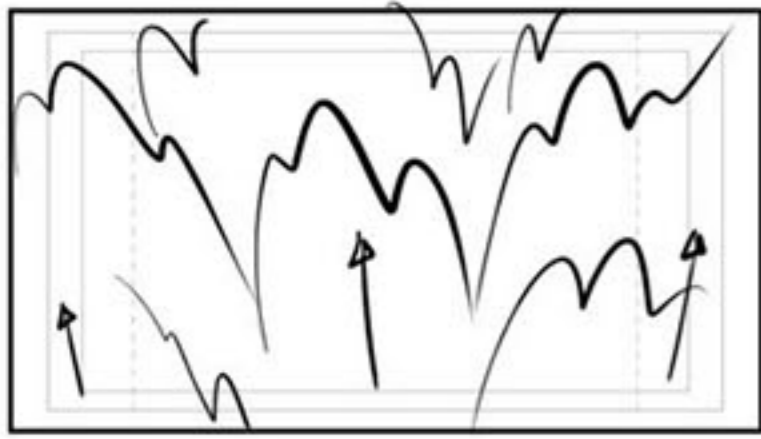

BB's sonic cannon enlarges

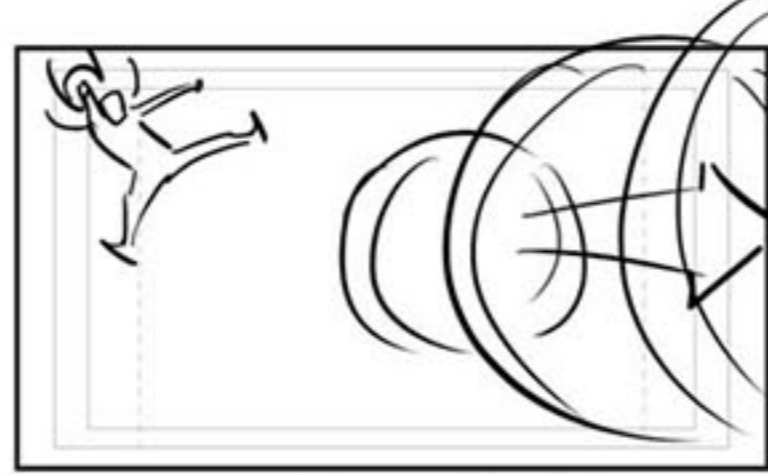

- and FIRES

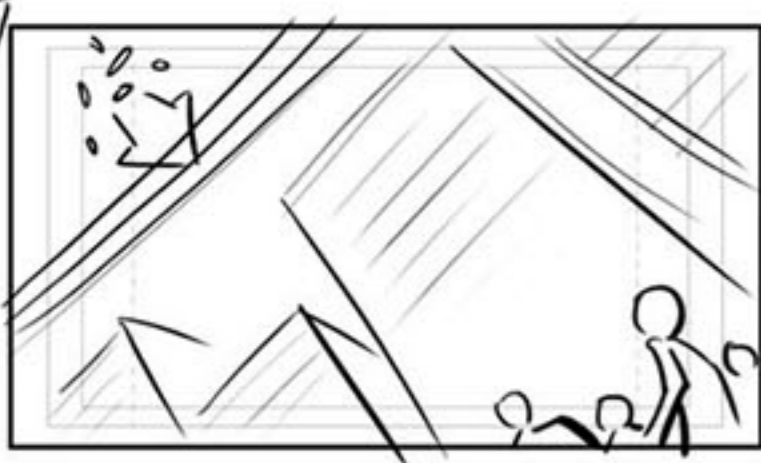
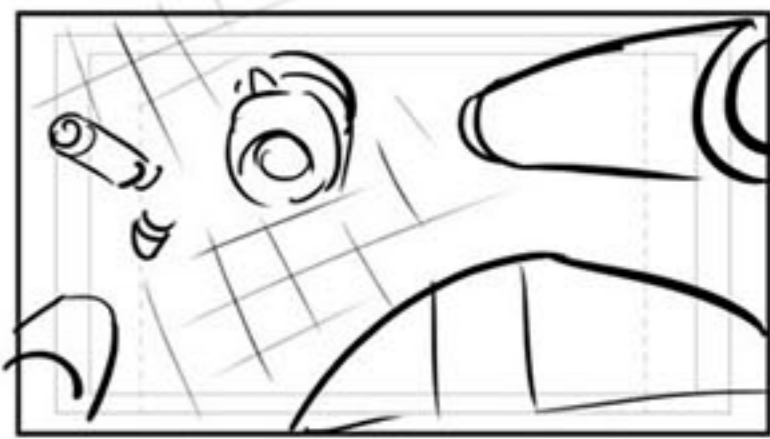
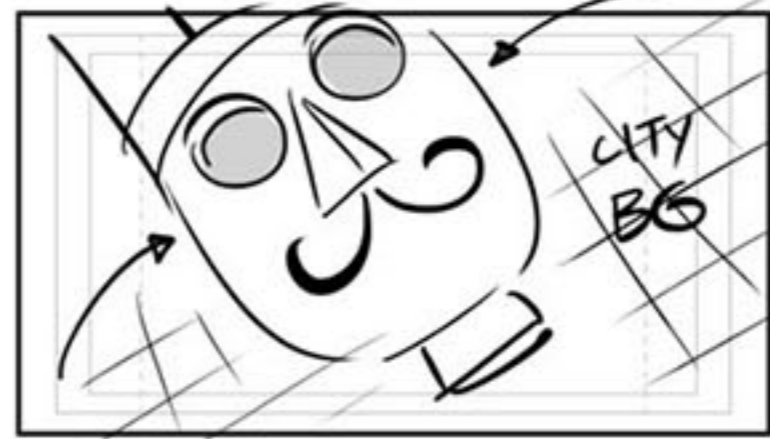
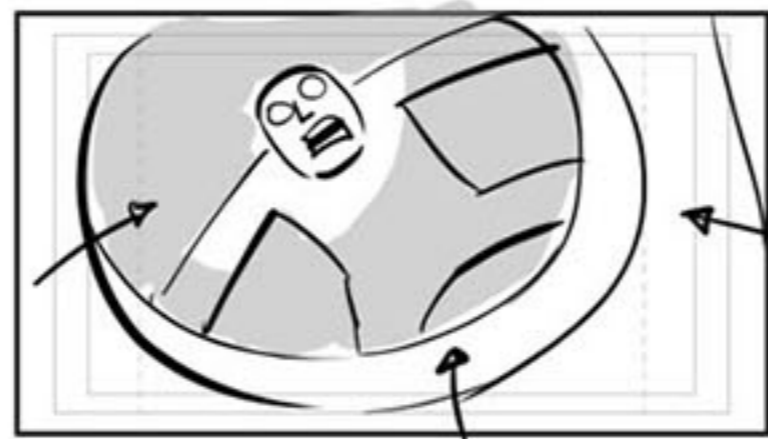
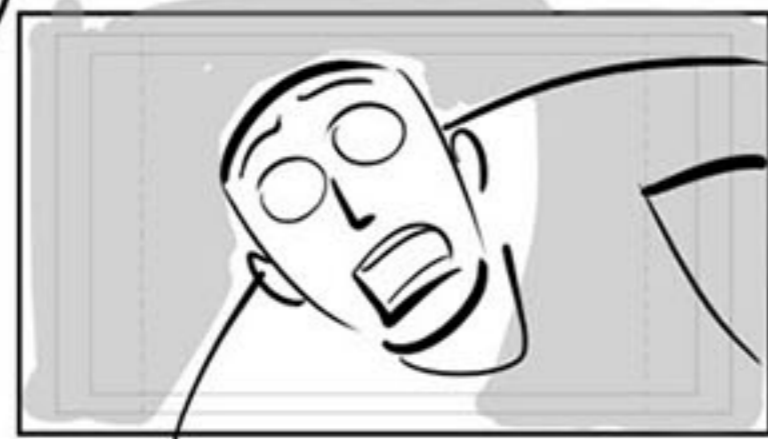

Parts land on rooftops

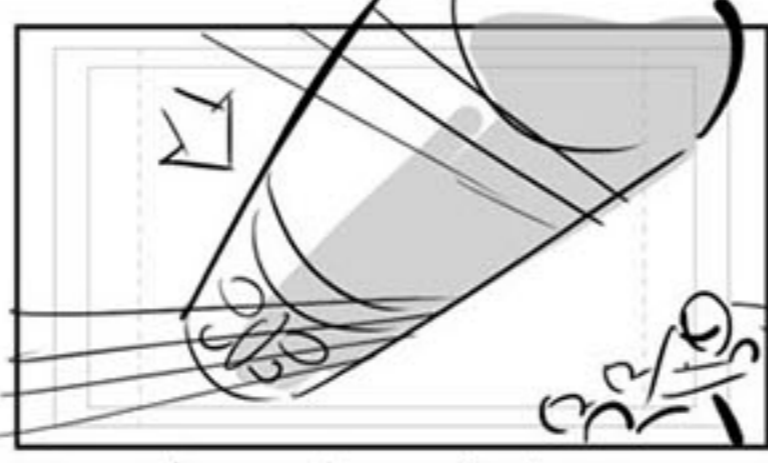

head cushioned by telephone wires



Truck out to see parts lying on rooftops

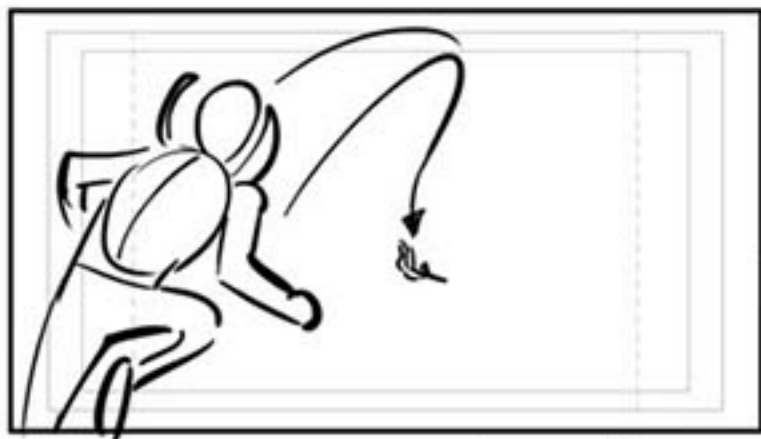

BB IN - pauses - dives down



32 BB: Here you go, officers.



Time to put the Toyman back on the shelf.

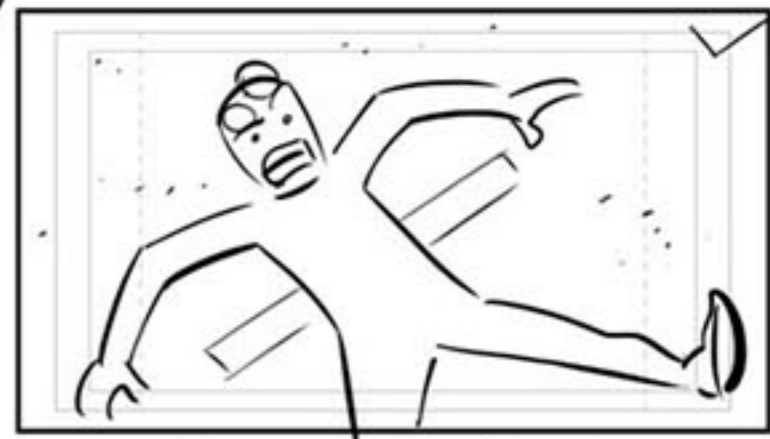

33 TM: No fair!

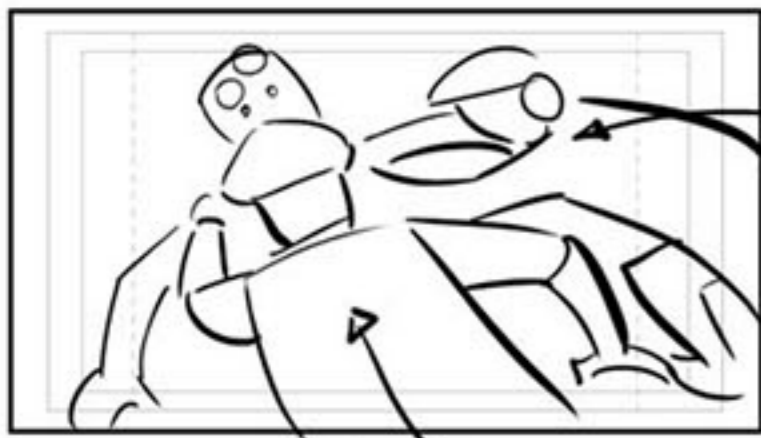

No fair!



No fair!



34 Cheering



35 CG: Blue Beetle... a moment?



36 BB: For the famed Cat Grant?



I'm at your service.



Heck, I'm at everyone's service!



That's just how I roll!

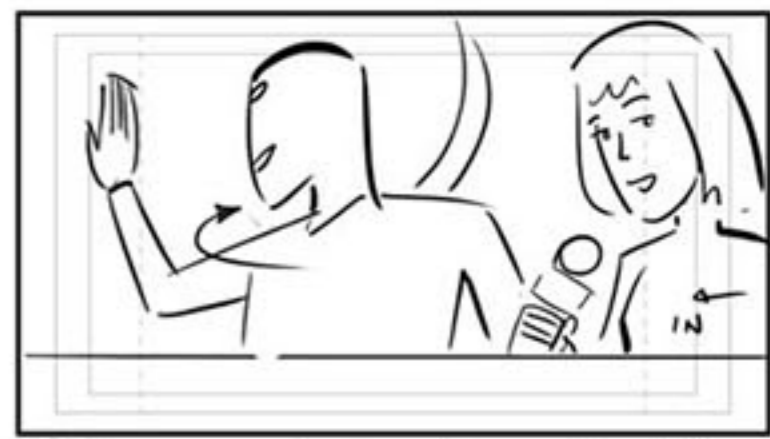

37 CG: You've been handling situations that-

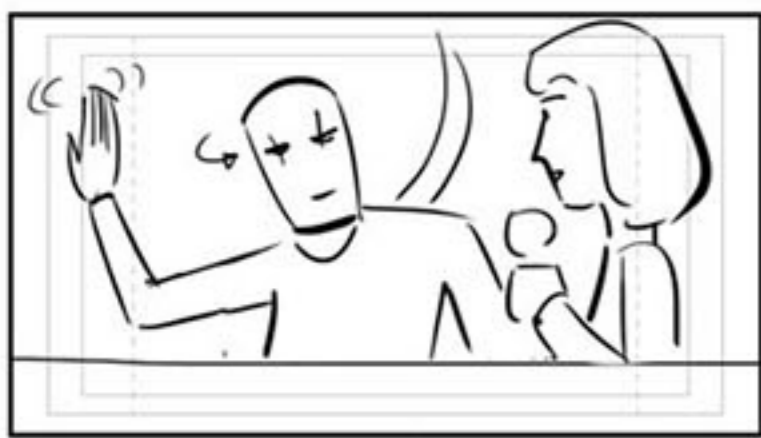

- once upon a time were a job for Superman.

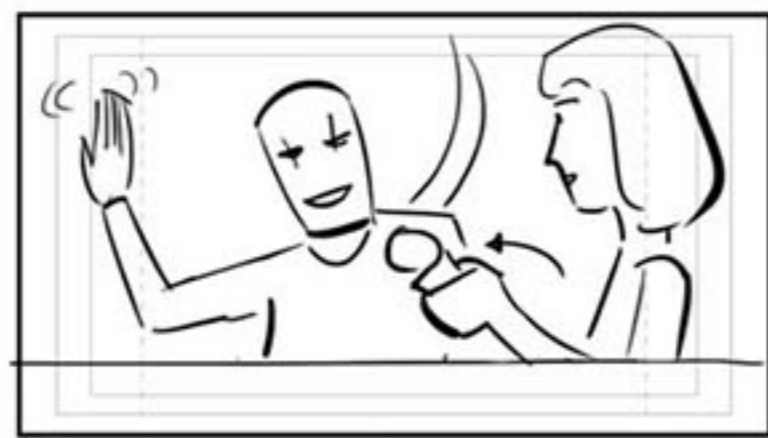

38 BB: Hey, if the Justice League's too busy-

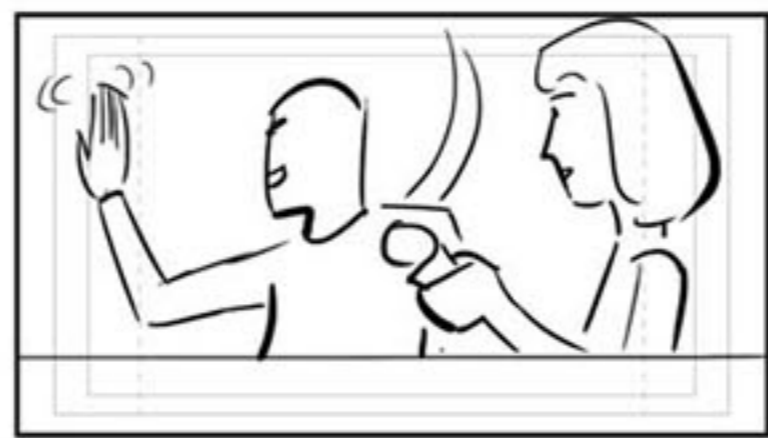

- I'm happy to take up the slack! 39 why am I still waving?



TRUCK OUT 40 I look like an idiot!



← pan to other screens 41 Jaime: Scarab! Get us out of there!

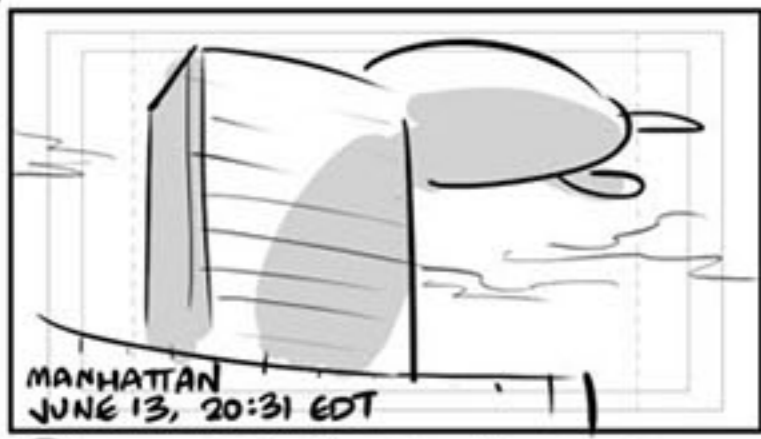

MANHATTAN  
JUNE 13, 20:31 EDT

42) SCARAB (VO): The Reach desires the crowd's adulation. And we serve the Reach.



45) A: Please. The meat loves their heroes.



48) Cheering 49) JR (VO): That's not the way I talk! And stop waving! I look like the queen of England!



53) BB: Let 'em watch.



43) A: Quite correct, Scarab. Fighting human crime is without benefit.



You worry too much, scientist.



PAUSE, THEN  
50) JR (VO): Great. Now I'm Peter Pan.

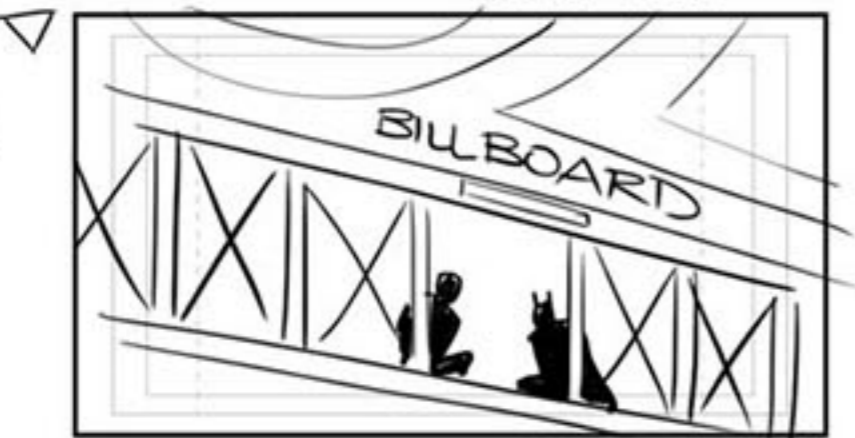

Making sure the crowd appreciates it...

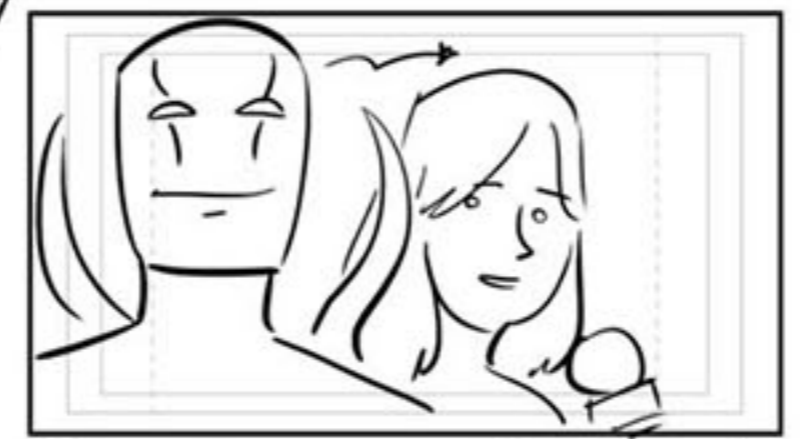
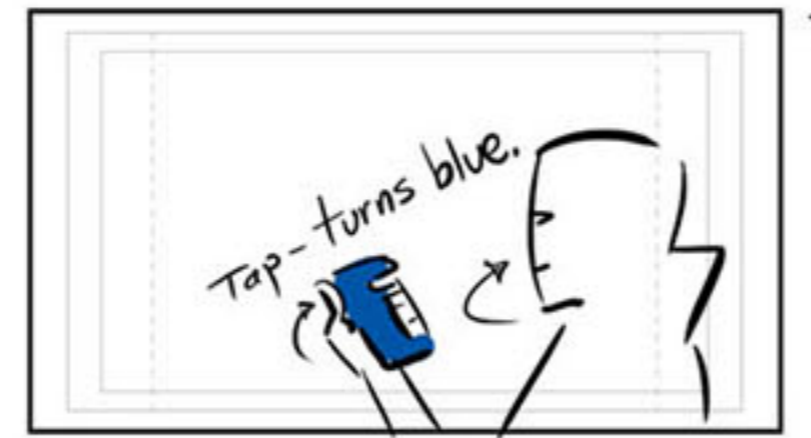

51) CG: As your profile expands-

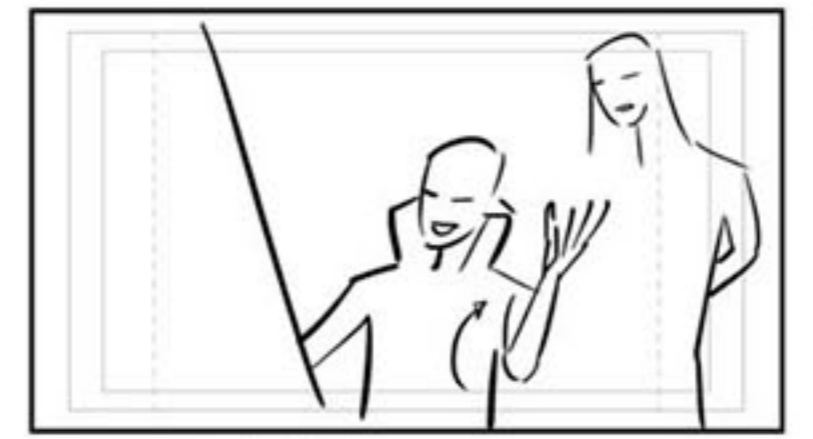

... priceless.  
44) S: Given the recent negative publicity over our hidden invasion fleet-



46) A: I am so honored by your kind attentions...

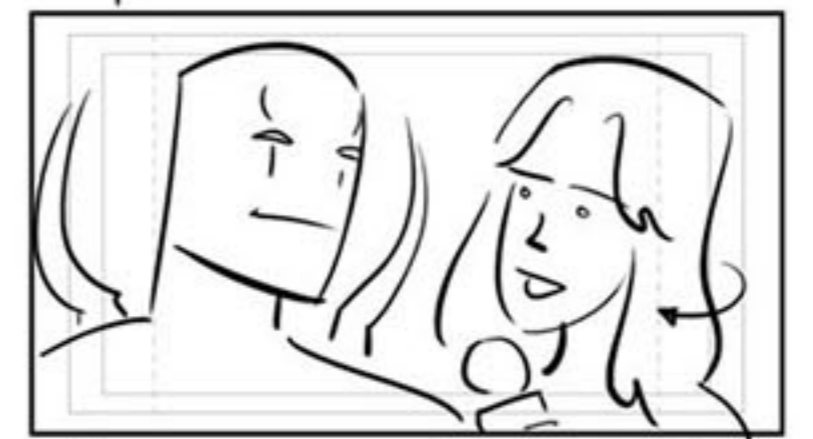

-do you worry about increased scrutiny?



POSEIDONIS  
JUNE 13, 23:45 UTC-2



-it is fortunate your puppet is appreciated at all.



47) BB - And so honored to be your hero!

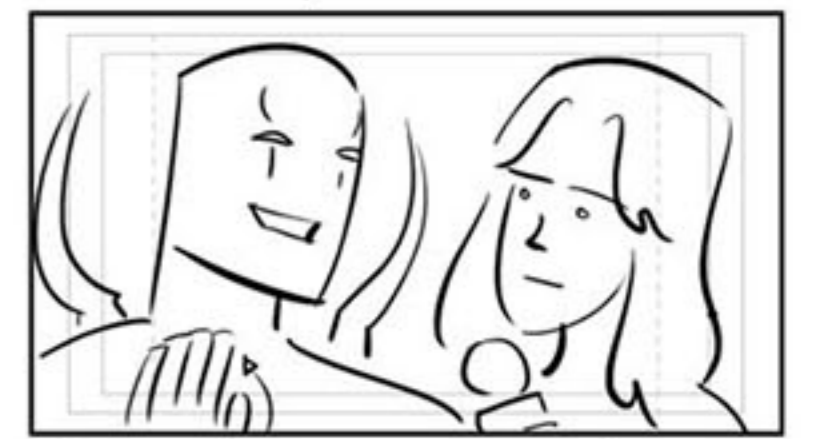

52) BB: Nah, I welcome it.



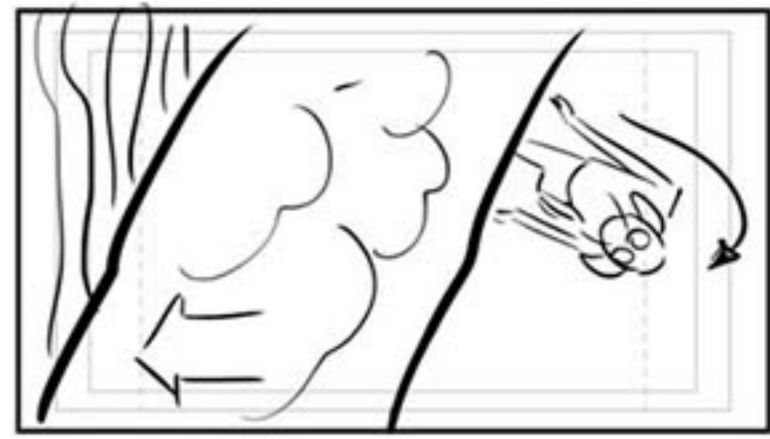
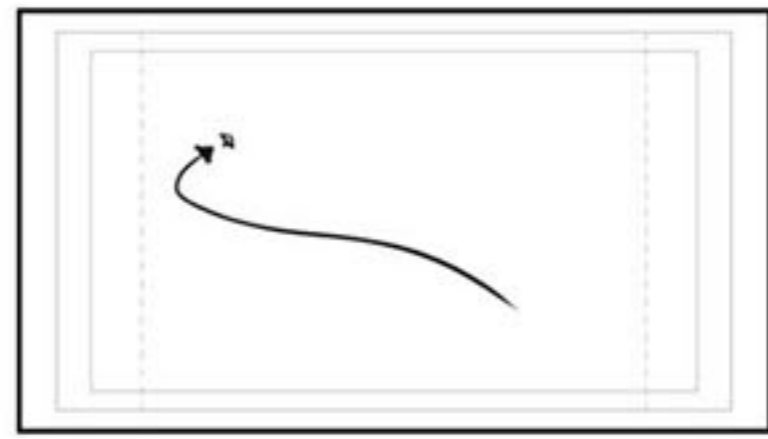
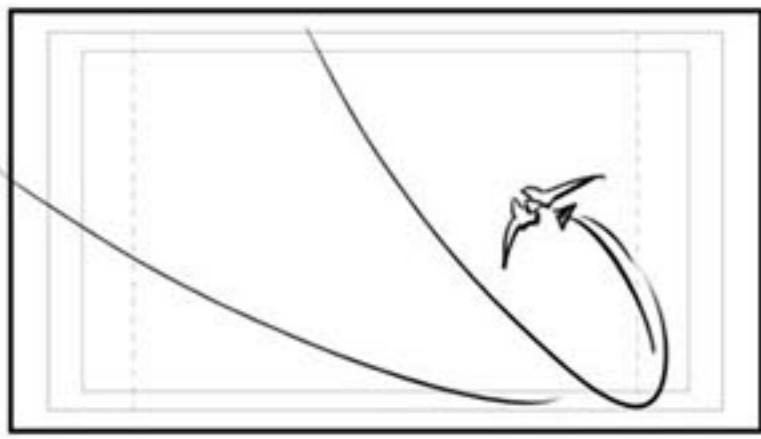

Cut to garden

Track with Lagoon Boy Swimming

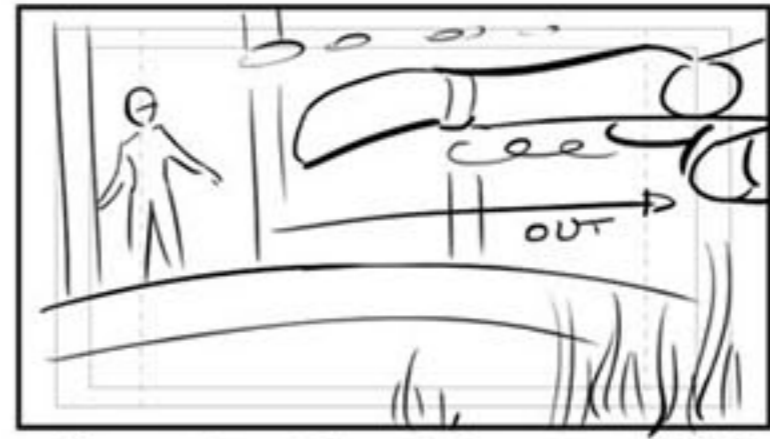

→ Cam gains ahead to see MM

Cam STOPS - LB gains OS

54 MM: Hi, La'gaan.

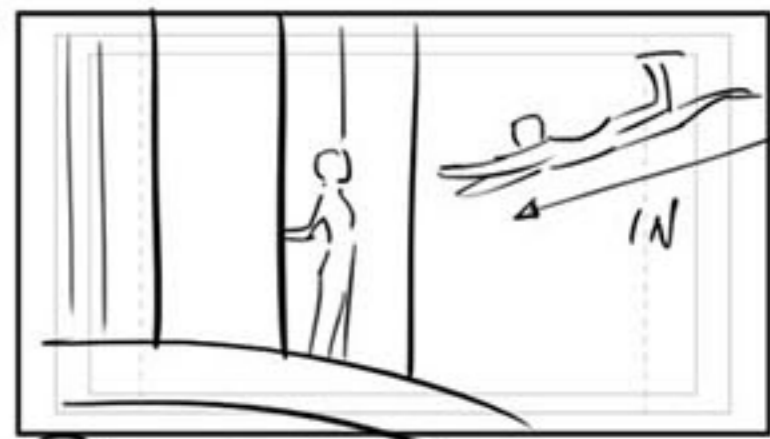
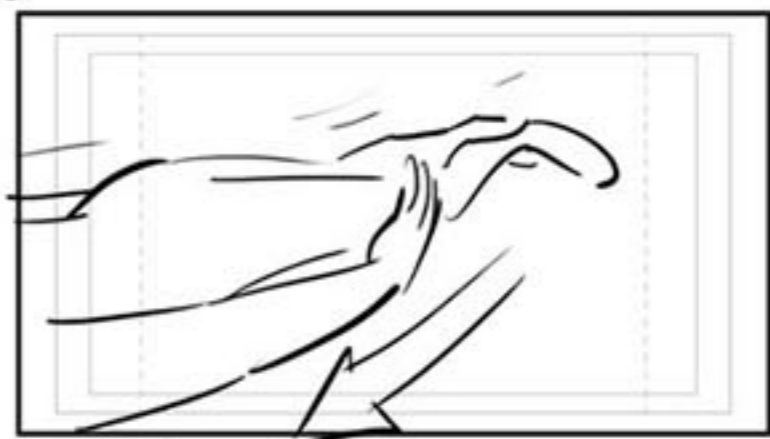

55 MM: I'm glad your leg's all healed.

56 LB: Angelfish! You're - here!

57 MM: I came to pick you up.



← Pan with - Bring you back to the surface world.

58 LB: That's so sweet!

I was just going to zeta back tomorrow.

He goes for a kiss - she turns her head

59 MM: I thought we could use the trip -



as an opportunity ...

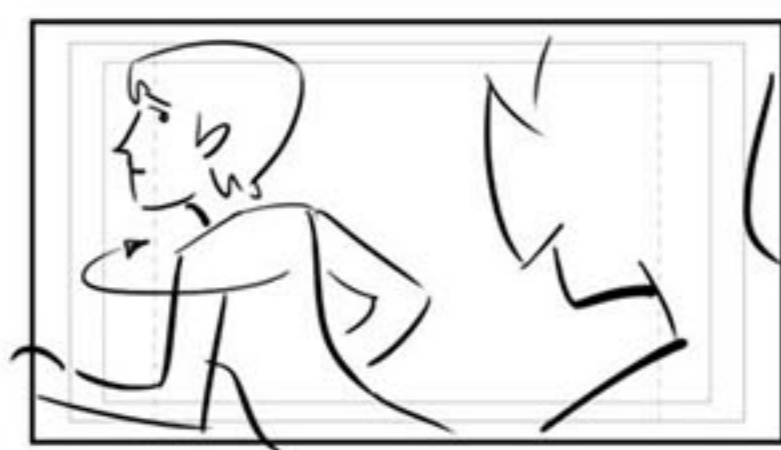

...to talk.



(60) LB: To talk? That's ... great.

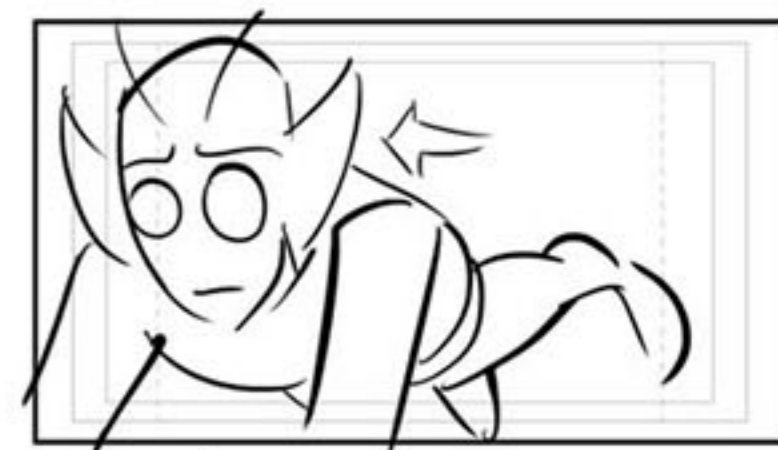

X DISS BG AS BB ANIMATES IN OVER LB

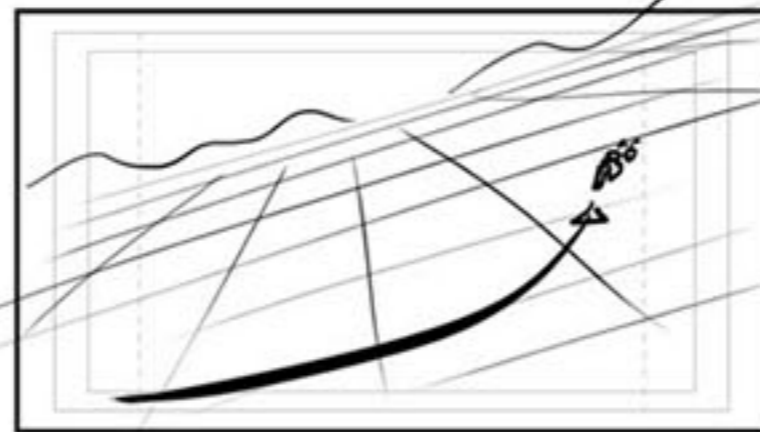
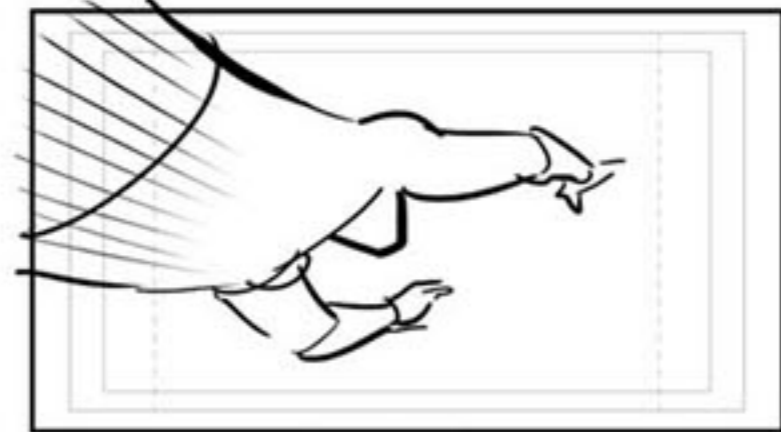

(61) SC(vo): We will soon arrive at your home, Jaime Reyes.

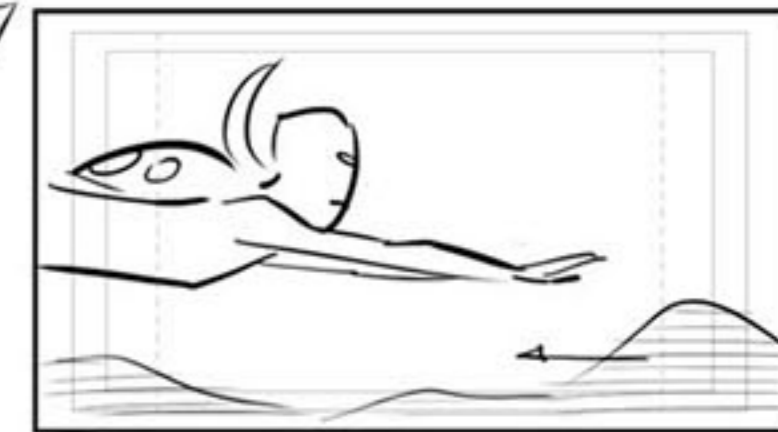

(62) JR(vo): Can we not? Nothing's worse than—

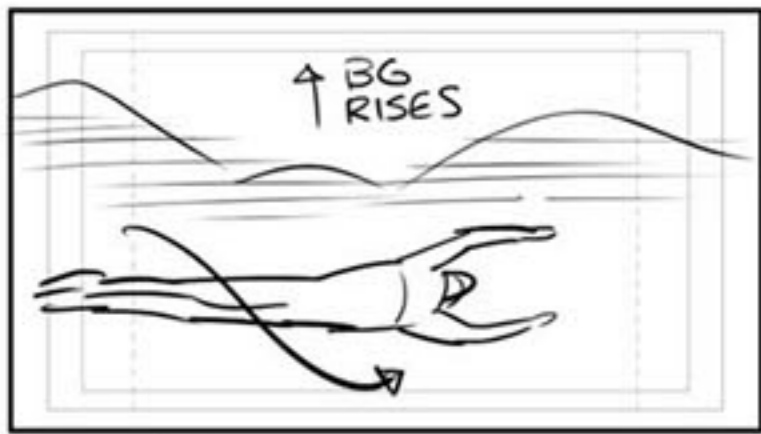

-watching you and the ambassador pretend to be me

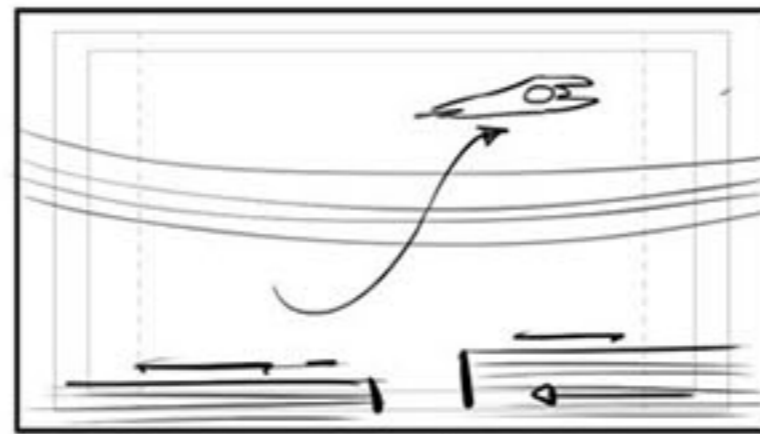
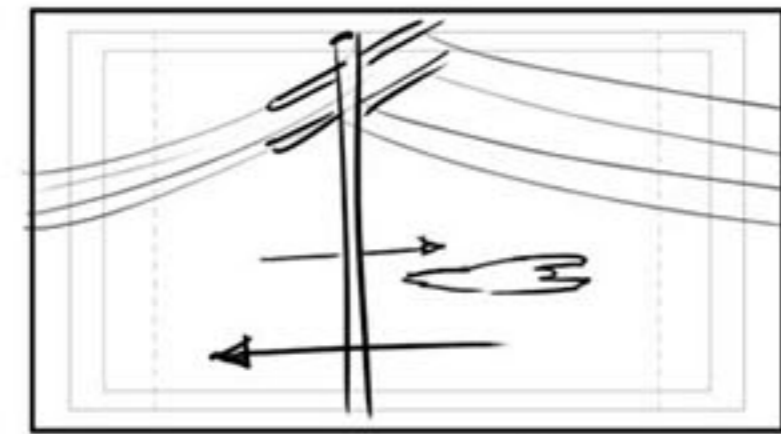

to my family.



(63) S(vo): Any alternative tactic would only endanger them.



(64) A(vo): Gratitude, Scarab. You took the words right out of my mouth.

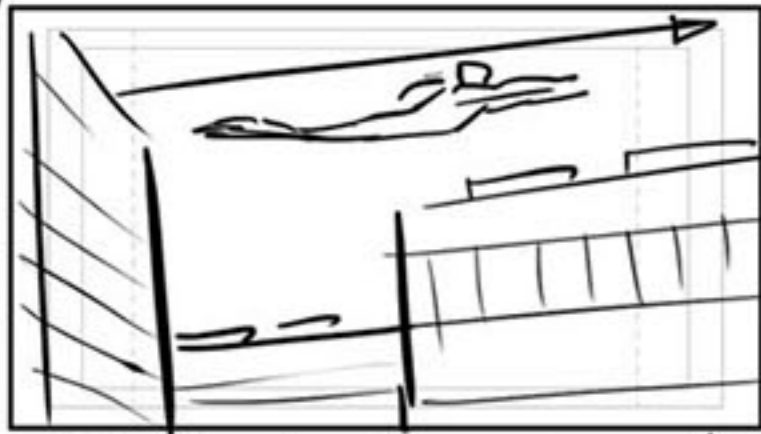

BB shoots thru scene/OS

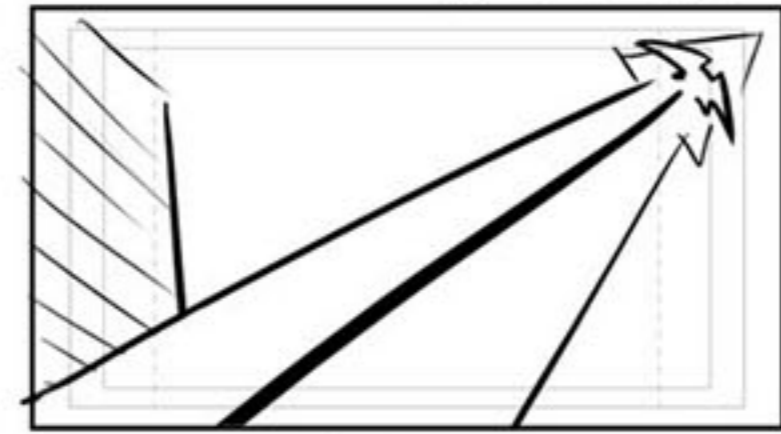

Grapple UP



Cable Wraps ankle



(65) SC(vo): Breach of defensive—

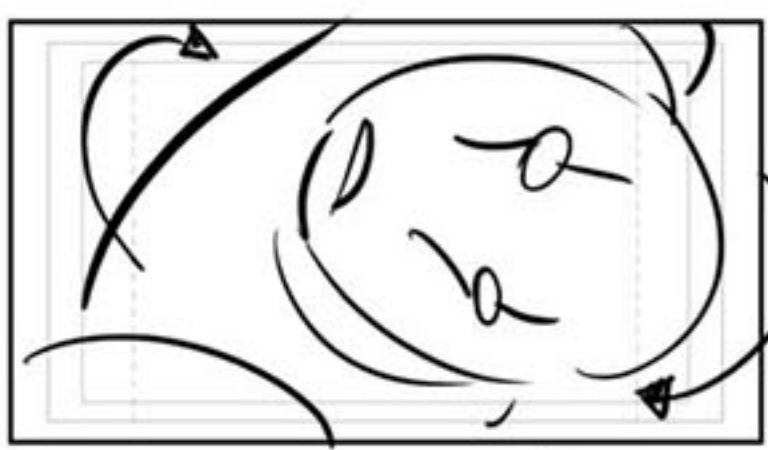

-perimeter!

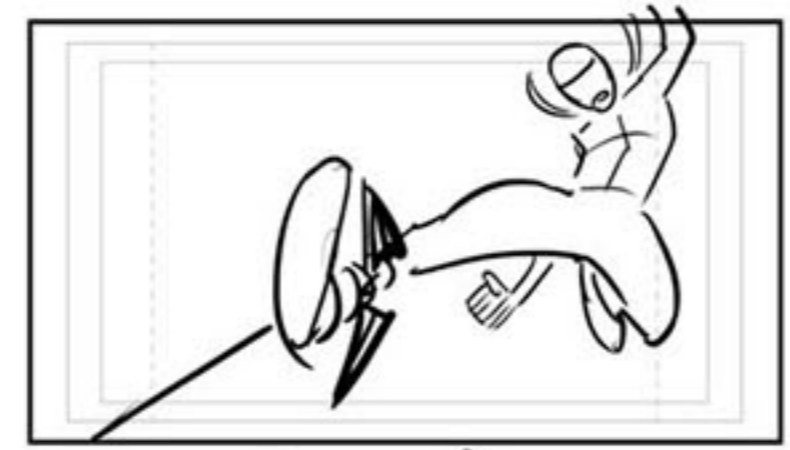
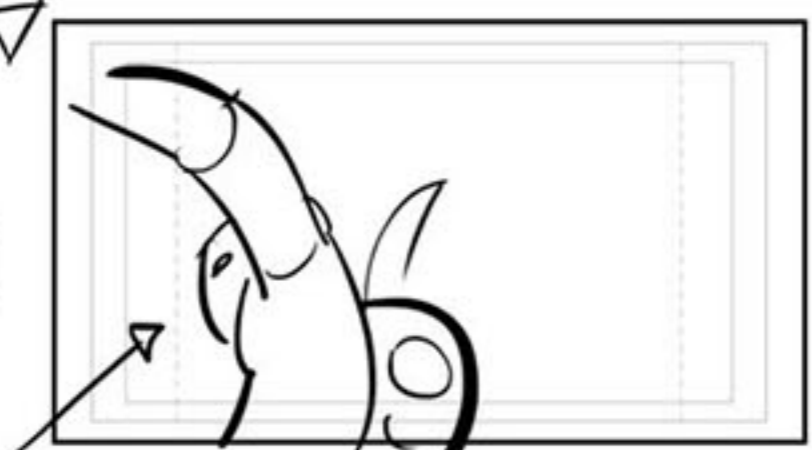

(STOP)



POV of Batgirl on rooftop

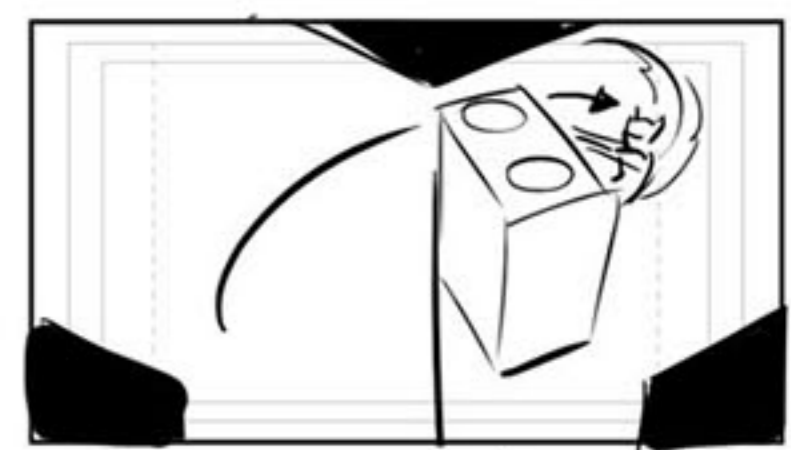

She moves around chimney



TRUCK OUT  
(66) AMB: Batgirl? What are you doing?

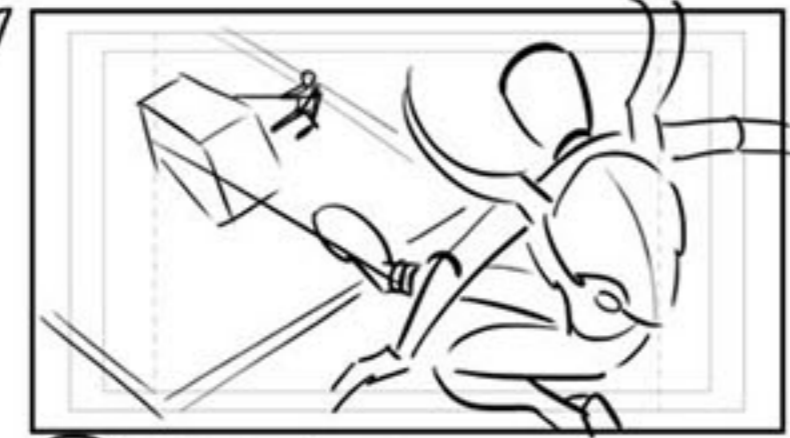

(67) BB: You know this won't hold us!



(68) BG: It'll hold for a couple of seconds!



TRUCK IN  
(69) JR/VO: Batgirl, please! They're gonna make me hurt you!



(70) Sc/VO: The Batgirl cannot hear your true voice, Jaime Reyes. This you know.

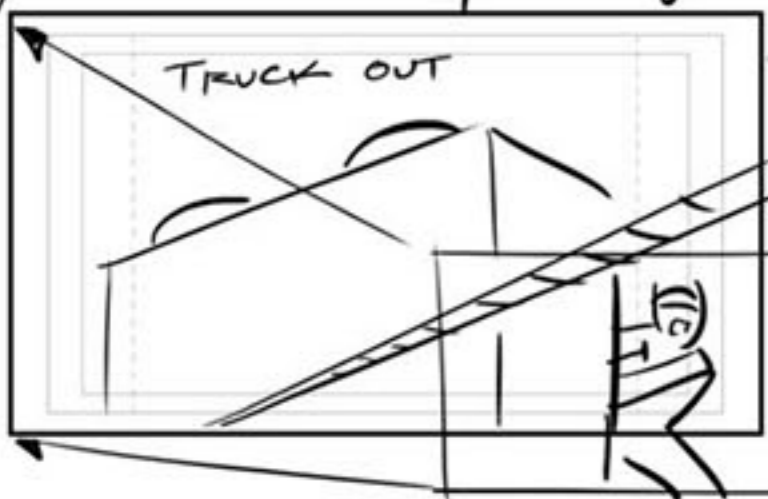

TRUCK OUT  
(71) BG: And a couple seconds—



(72) I: Is more than—



TWIST TRUCK IN  
—(VO) I need!



BB flips over—rocket back blasts into cam



Go to IMPULSE TIME—Blast slows to PULSES

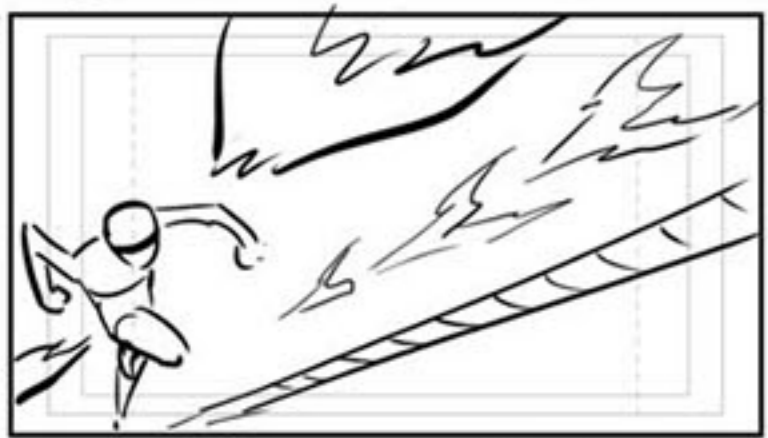

Imp runs up cable between streams of pulses



Downshot on action



Cable snaps

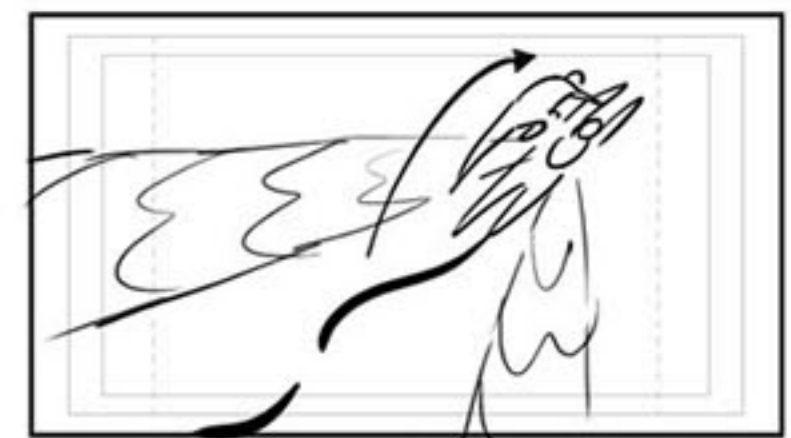

Imp leaps onto BB's back as time speeds up again



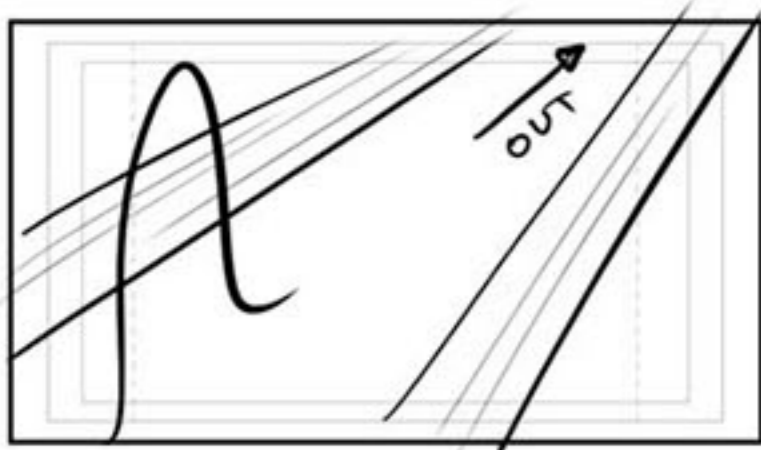

Both zip out



Imp holds onto BB  
(speed blur BG)



Both flip over

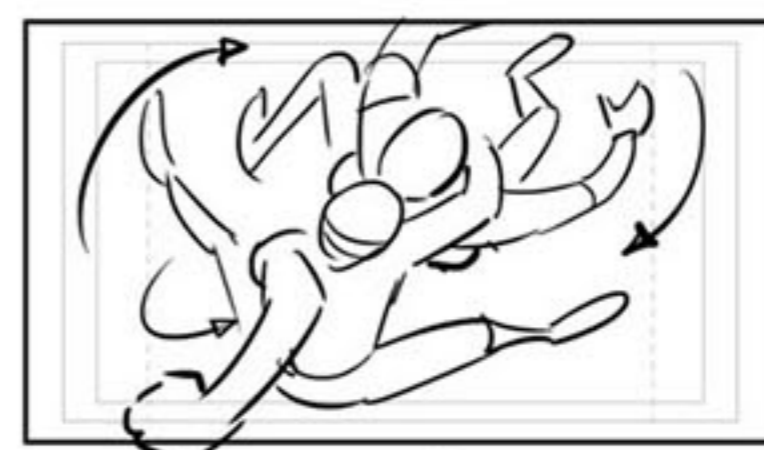

Imp antics to punch



Imp punches rapidly

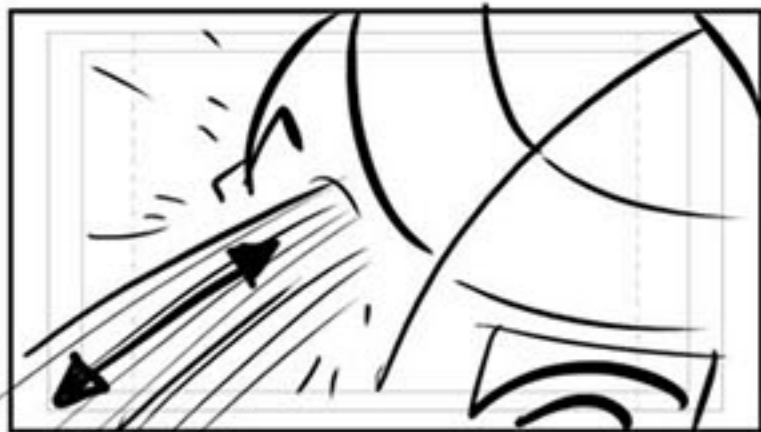

Close on jetpack  
getting hammered



It fritzes out

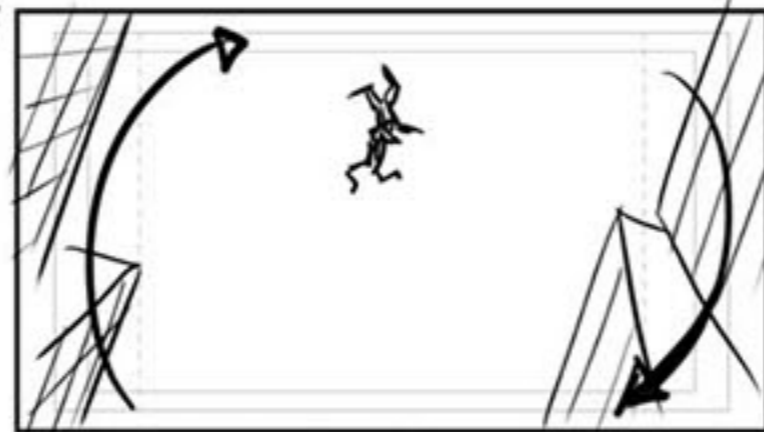

UPSHOT - Buildings spin  
360 in FG



Both fall toward cam



Impulse kicks off BB  
(73) Imp - effort walla

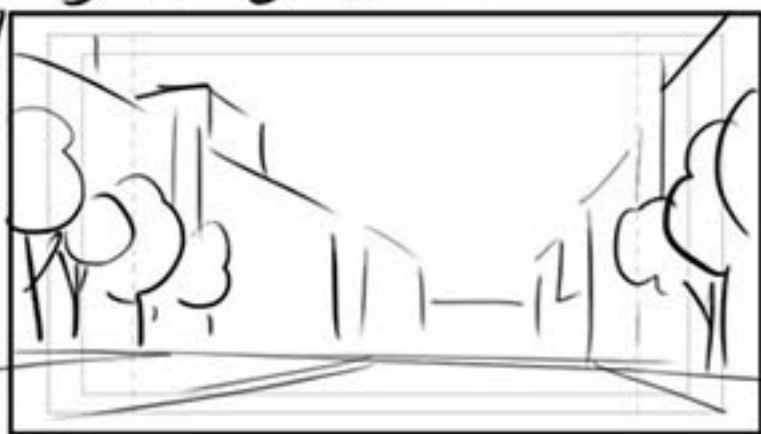

SHAKE



BB drops into FG

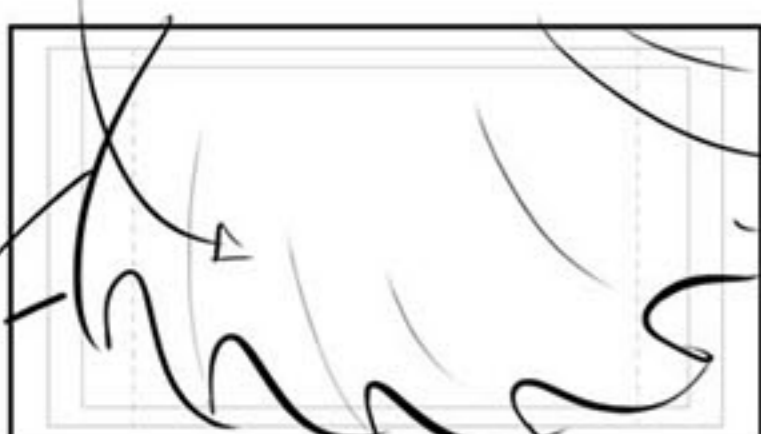
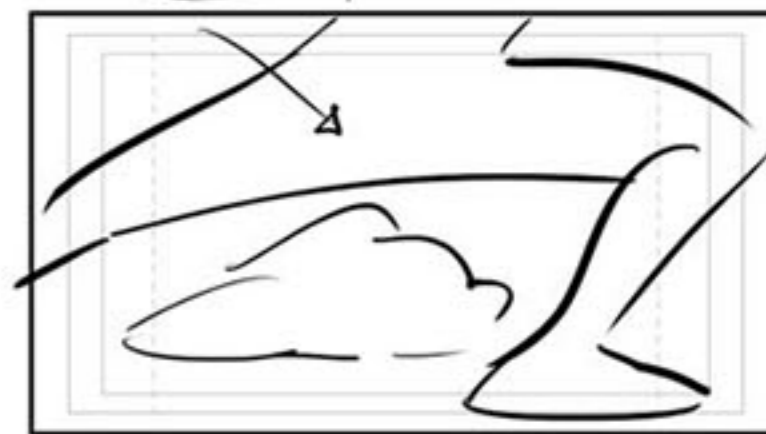

Cape drapes in



(74) BG: Sweet dreams



Blue.

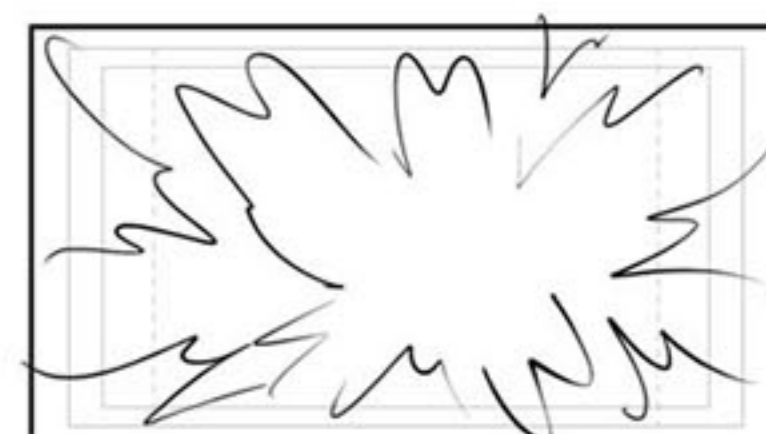

POP!

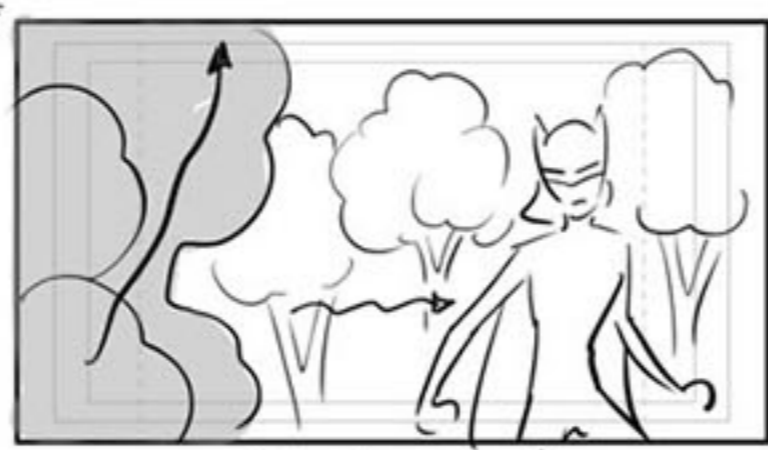
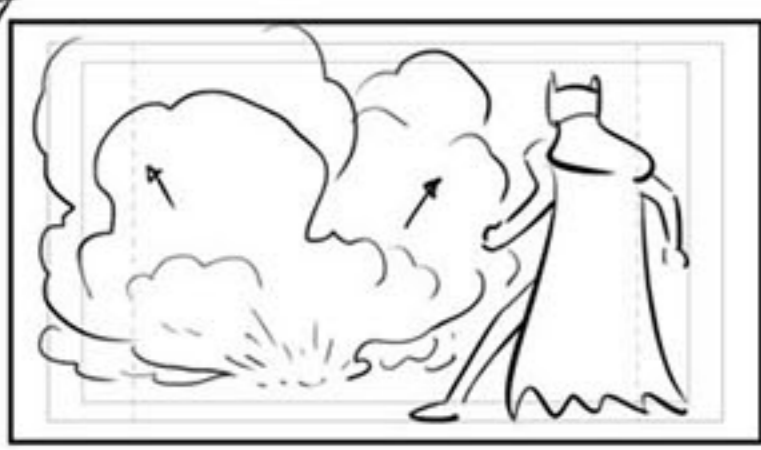

BG steps aside

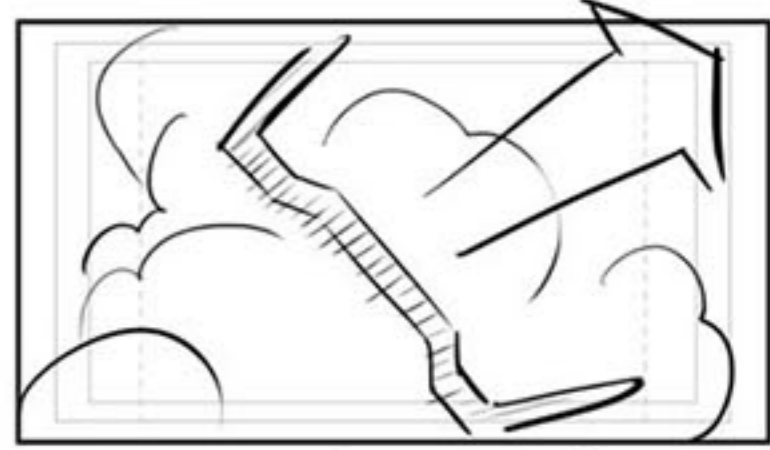
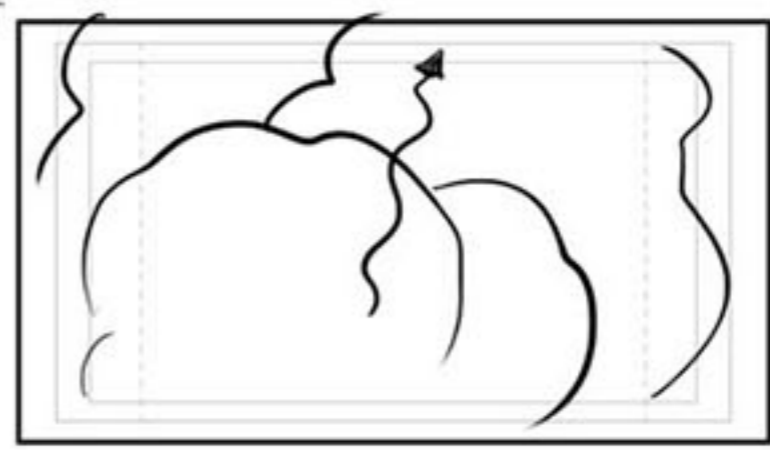

Staple flies out of smoke

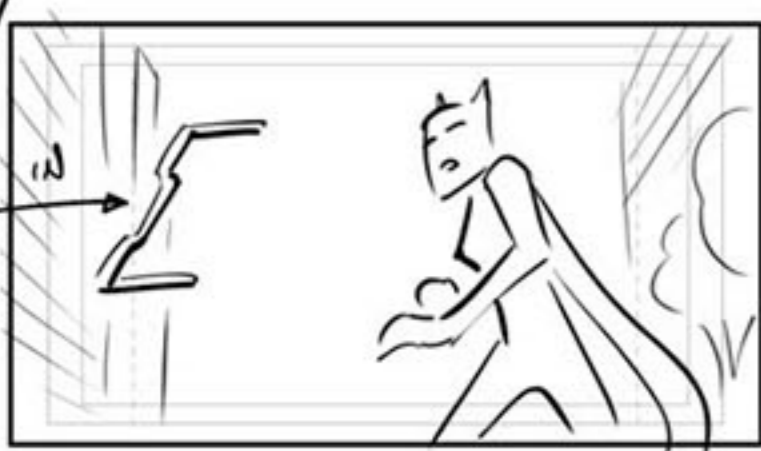

Slam into tree trunk  
75 Impact



She settles



2nd staple IN  
76 Impact



She droops  
- GROAN

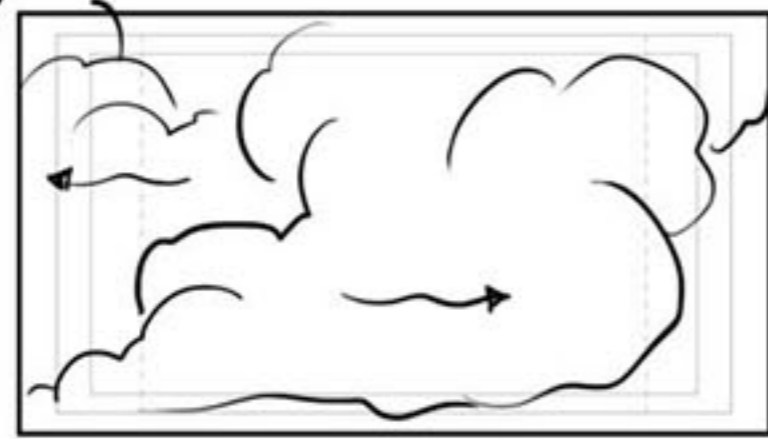

Impulse streaks thru-  
knocks BB FWD

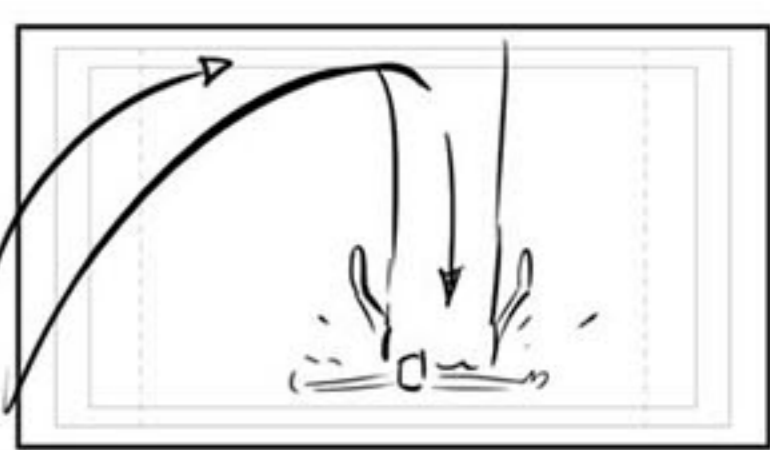
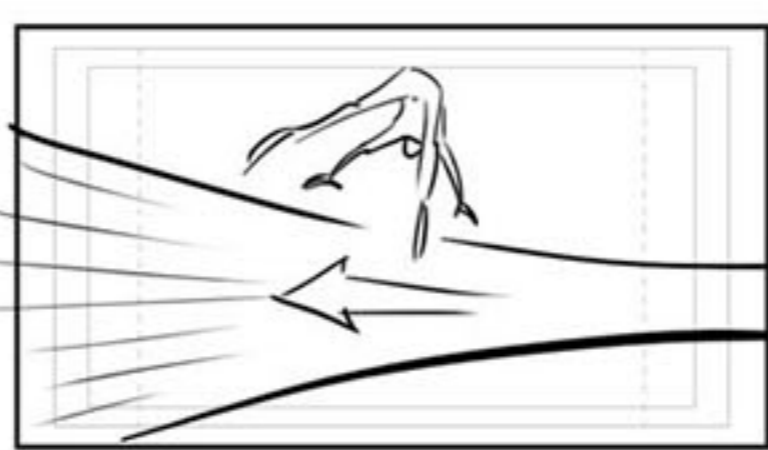



77 AM (vo): Scarab, what are you waiting for?

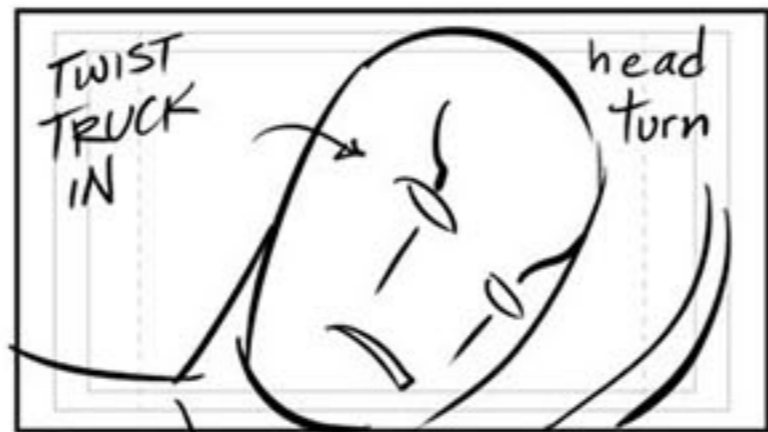

78 SC (vo): I am establishing the Impulse's pattern of movement.

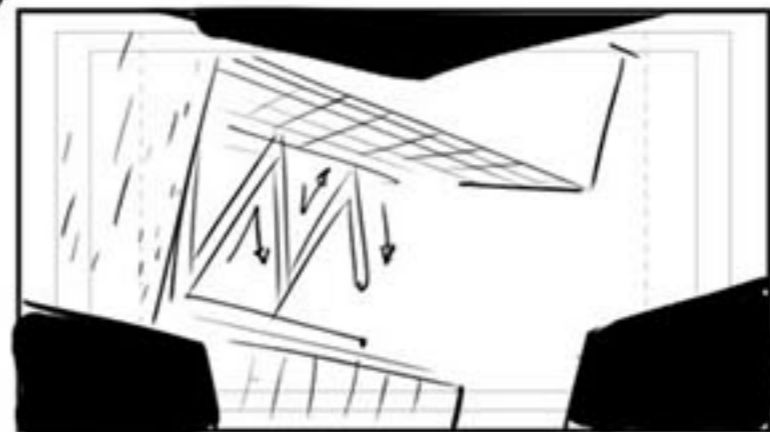

POV-Ground @ left Impulse is a streak bouncing off buildings (BG rotates - where he - target graphic ON)

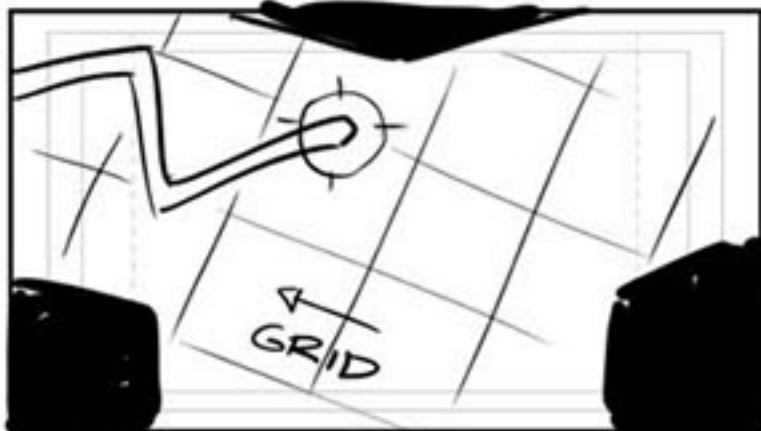

Screen graphic DX over BG - will be.

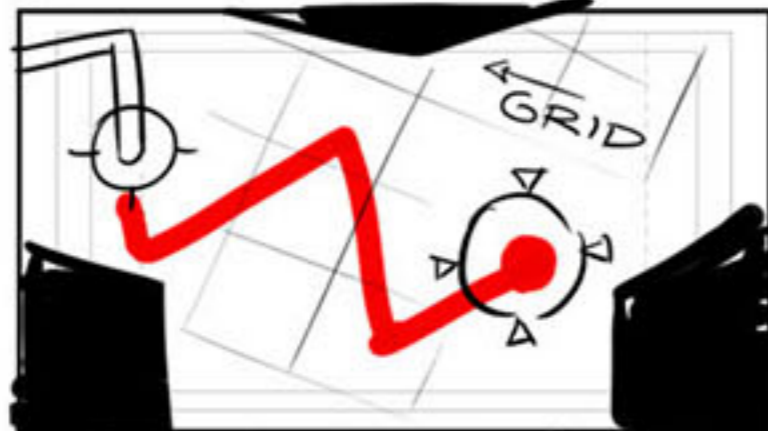

- Project ahead of Impulse



80 SC (vo): Target -



PAN -acquired!

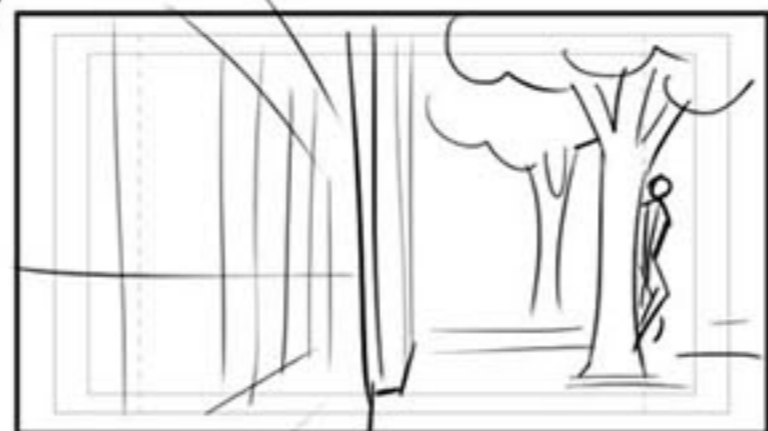
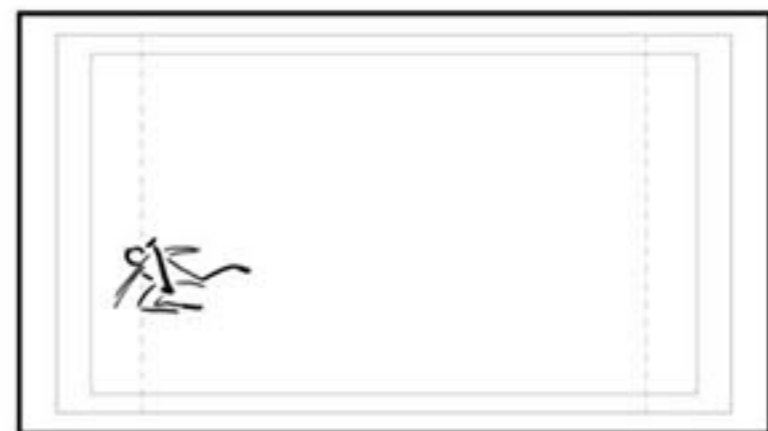
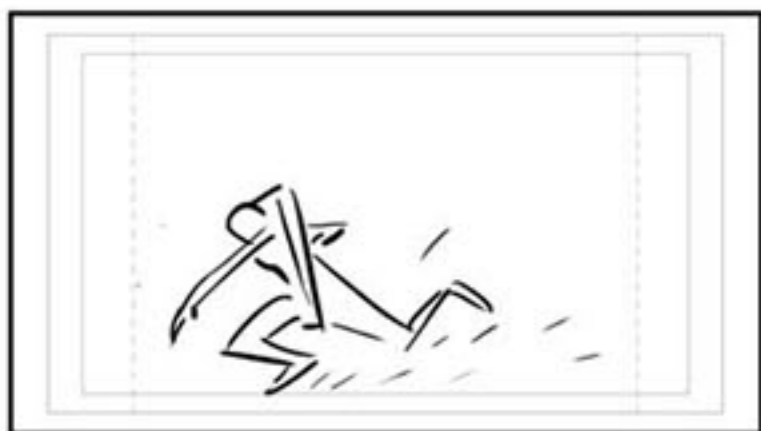
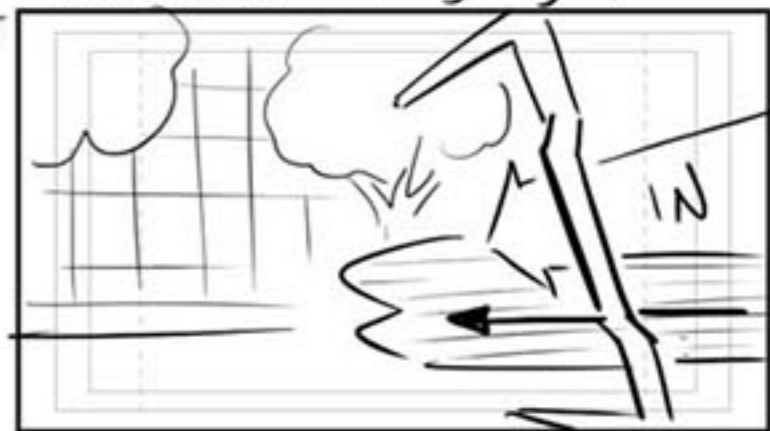

Batgirl



81 IMP: Impact

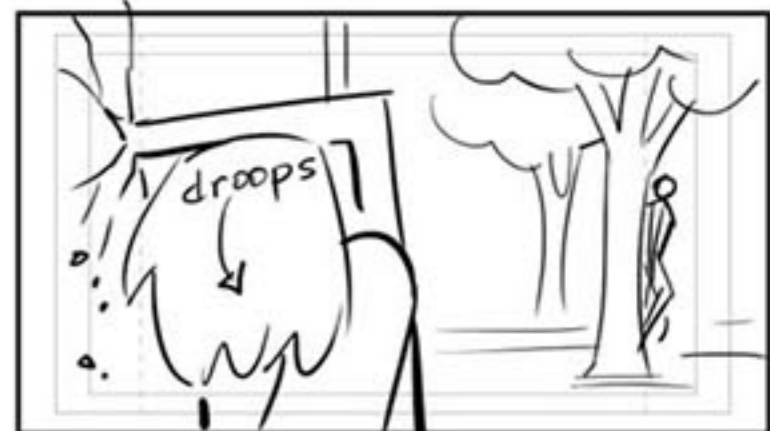

moan



82 JR (vo): Okay, they're down. You won, let's go.



Rack to FG



83 AMB (vo): I think not.



As this street is deserted, we must seize the opportunity.

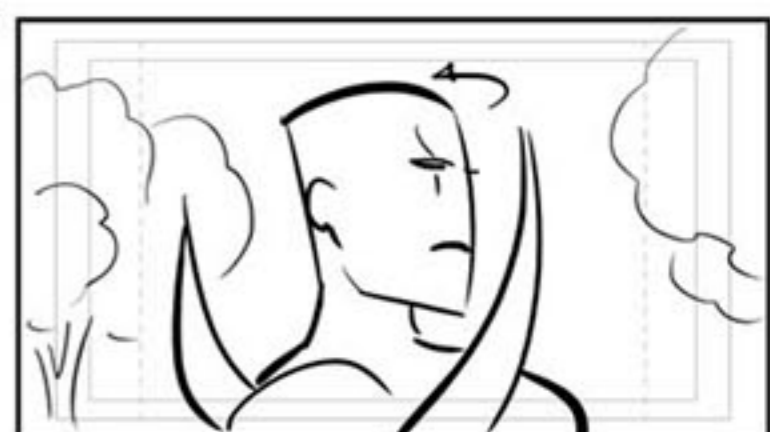

Scarab...

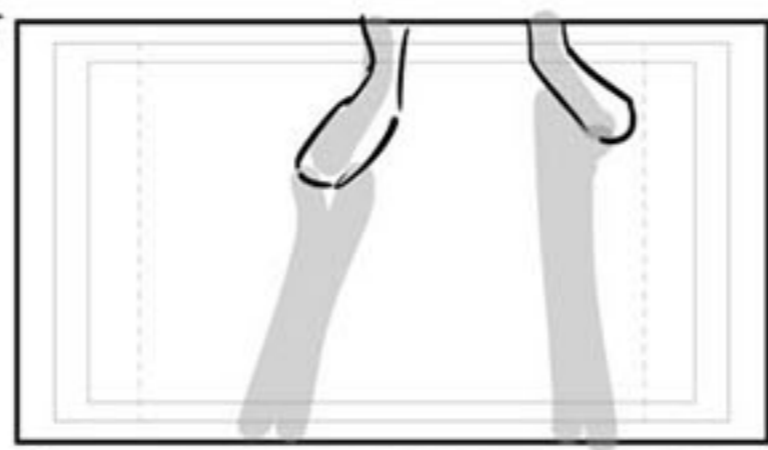
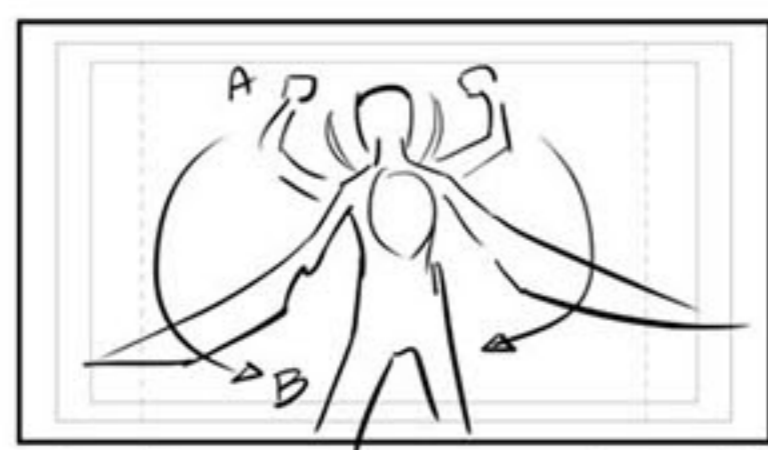

84 AM (VO): Kill them both.

hands up, then-SCHWING two giant blades!

(SCRIPT CALLS FOR A GUN, BUT I THINK BLADES ARE MUCH SCARIER...)

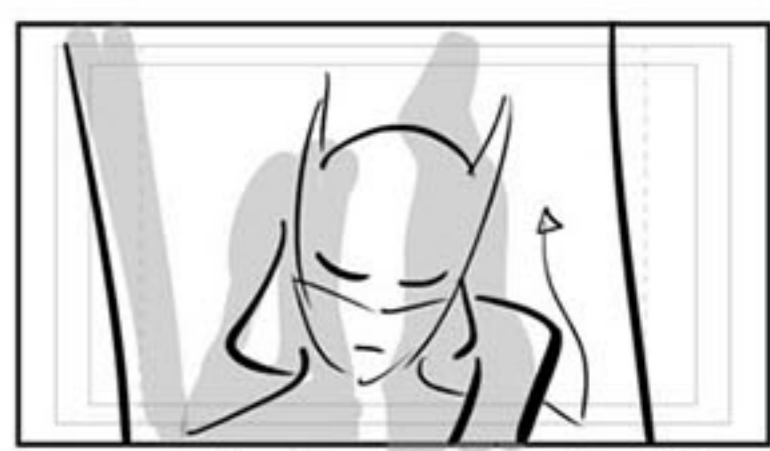

GROUND ANIMATES INTO CAM

TRUCK IN to this

Shadow of blade UP

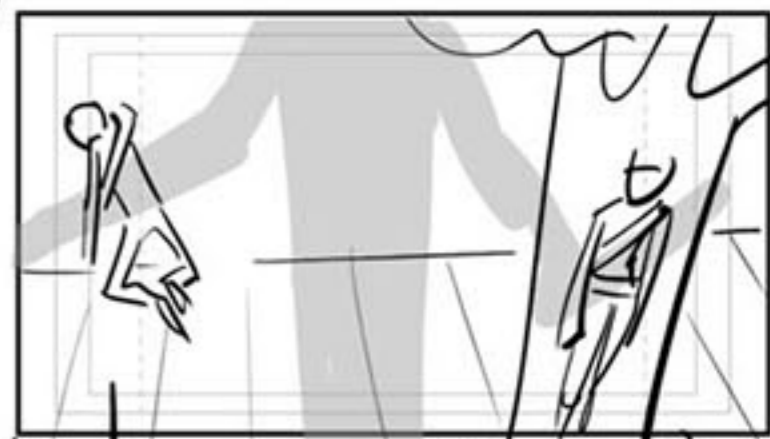
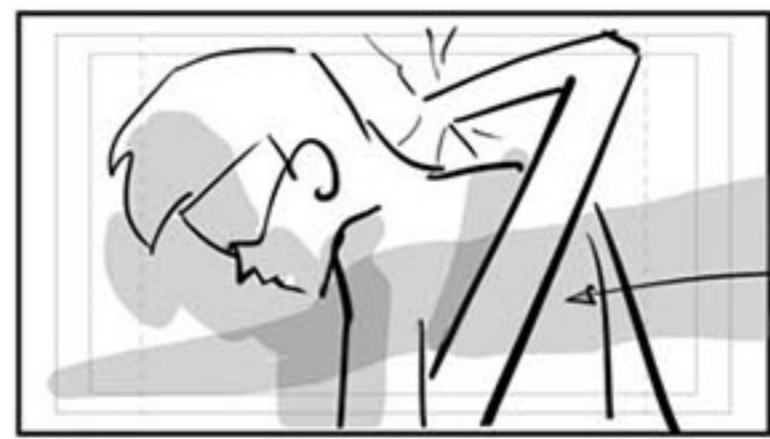
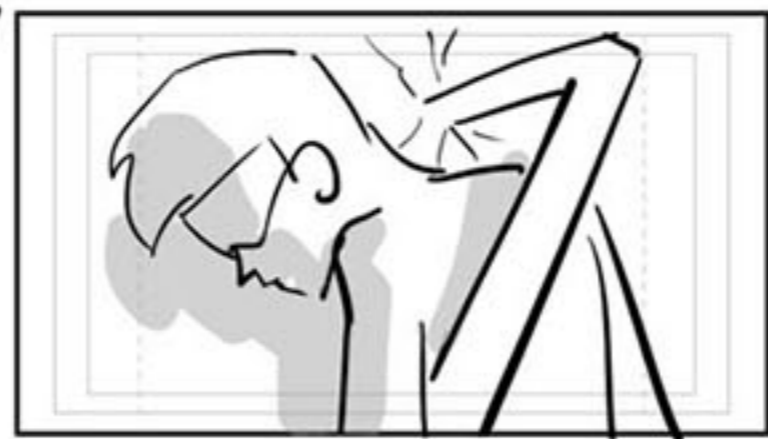
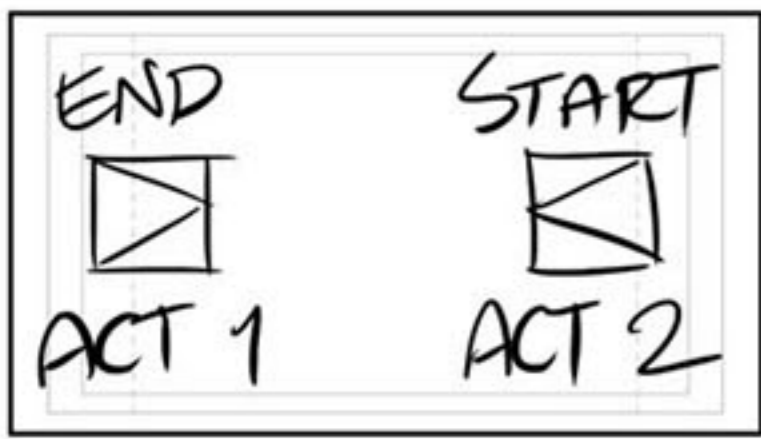

85 JR (VO): Scarab! You

- don't have to do this!

86 AM (VO): But he does.

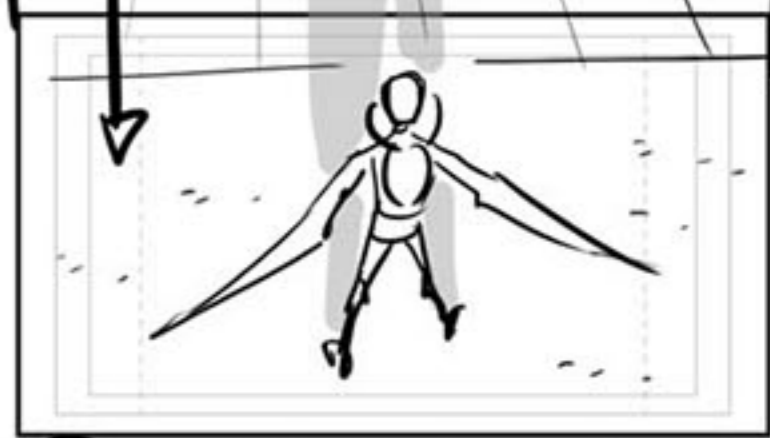
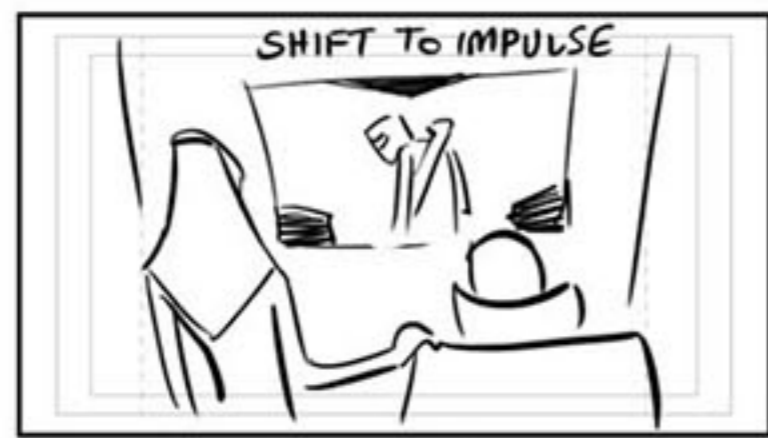

- for you to helplessly observe your own body murder your former friends.

The first kills are always the hardest, my boy.

(VO) Might as well get them over with.

87 AM (VO): And so do you. In fact, it will be a good lesson -



START TOWARD IMPULSE

(88) JR(VO): Scarab, please!

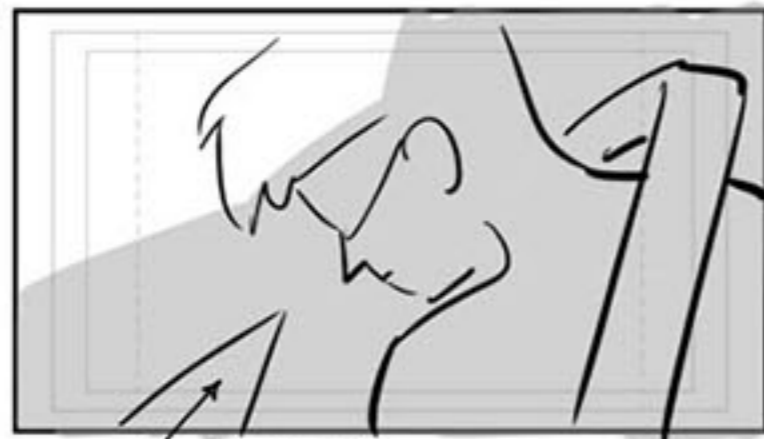

BLADE IN

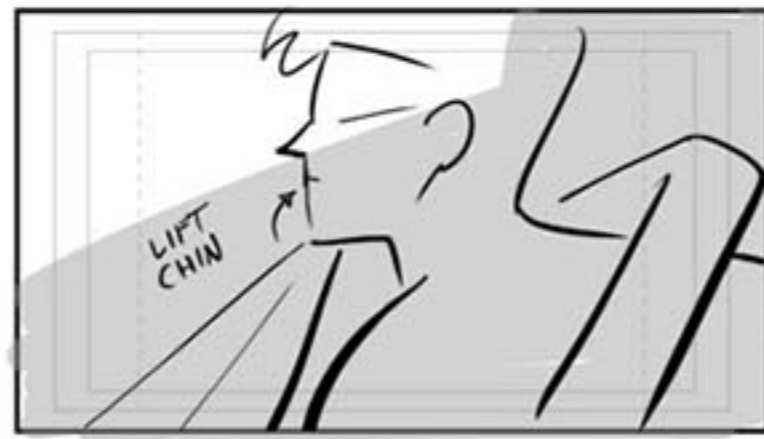

LIFT CHIN

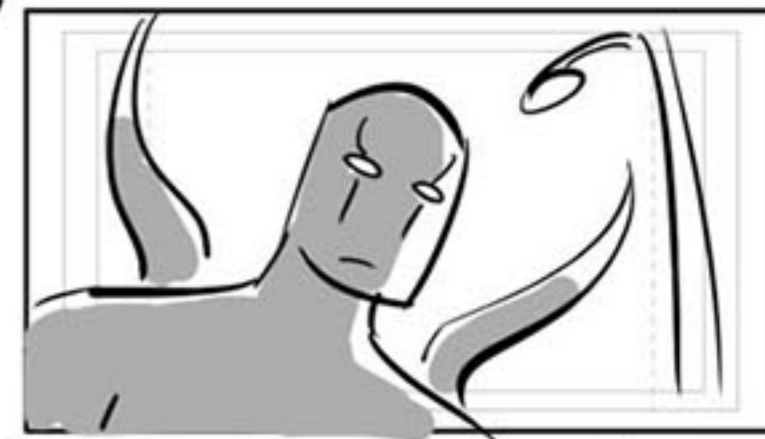
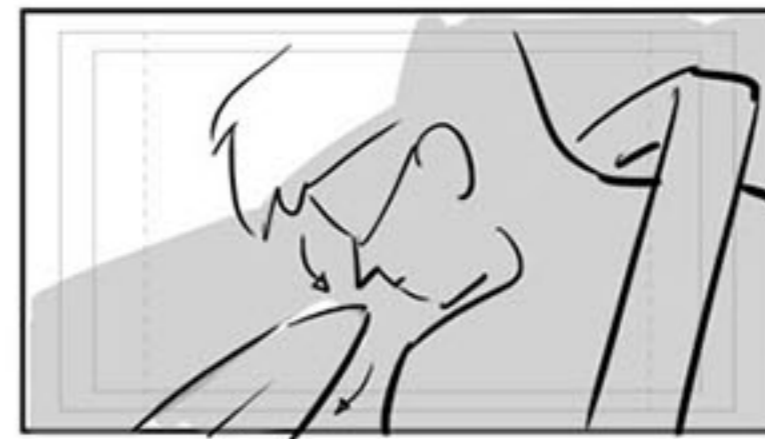

(89) Sc(VO): I must do as design-

Can't VO: WE fought side by side with these guys! Do something!



ARM UP

-parameters indicate.

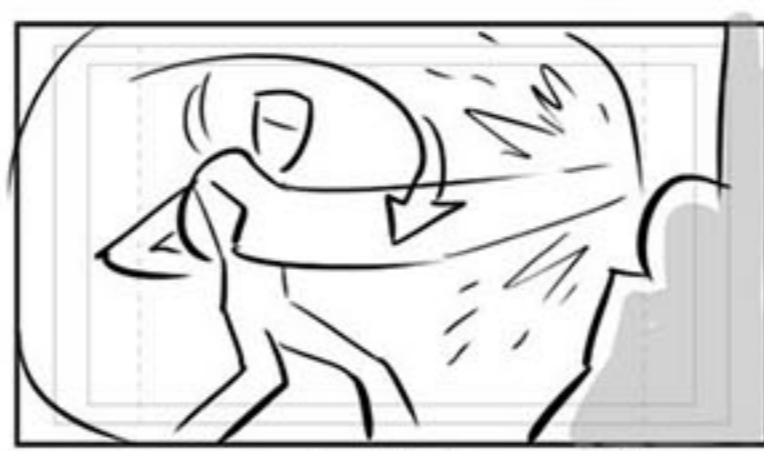

Force bubble ON - blade hits it



SCRAPE



TRUCK OUT

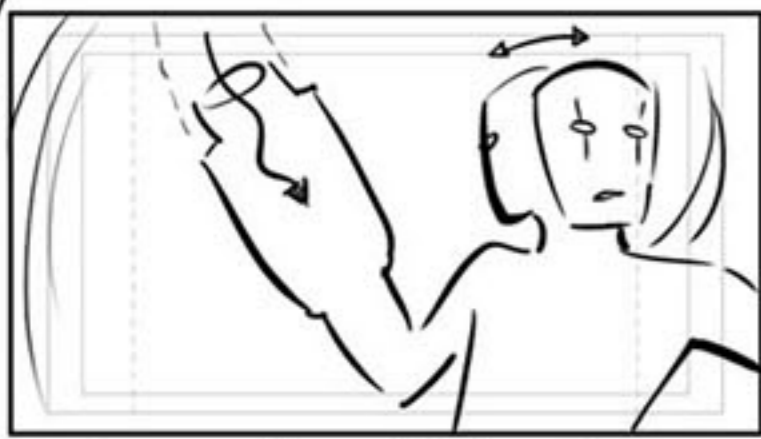

look around as blade changes to plasma cannon



BLAST (fills inside of bubble)



Energy fills frame

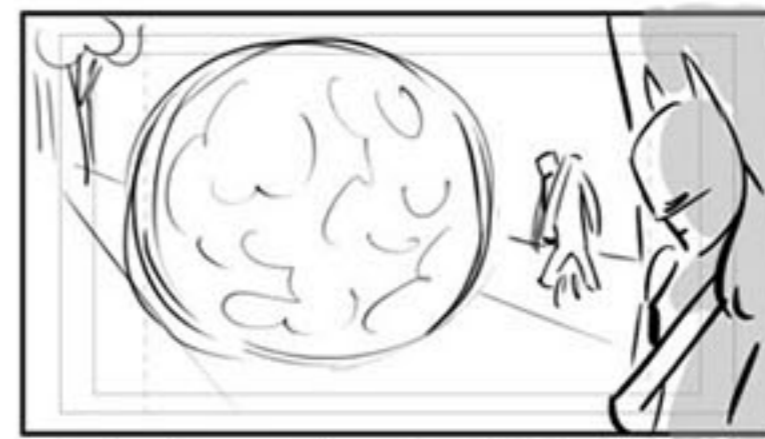

Cut to EXT-BLAST-BLAST

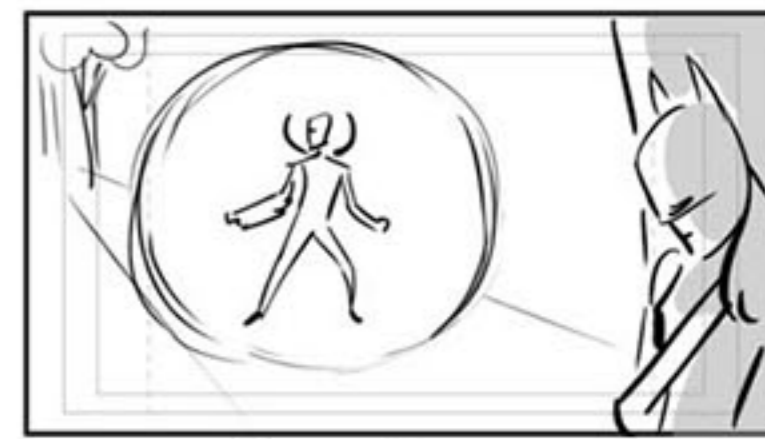

Energy dissipates

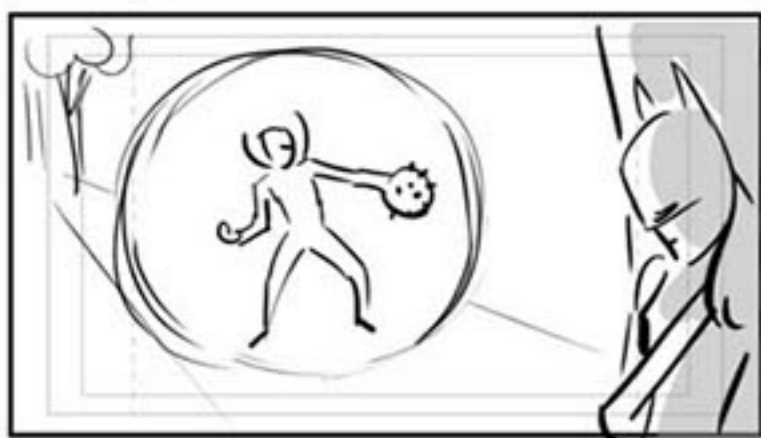

form mace hand

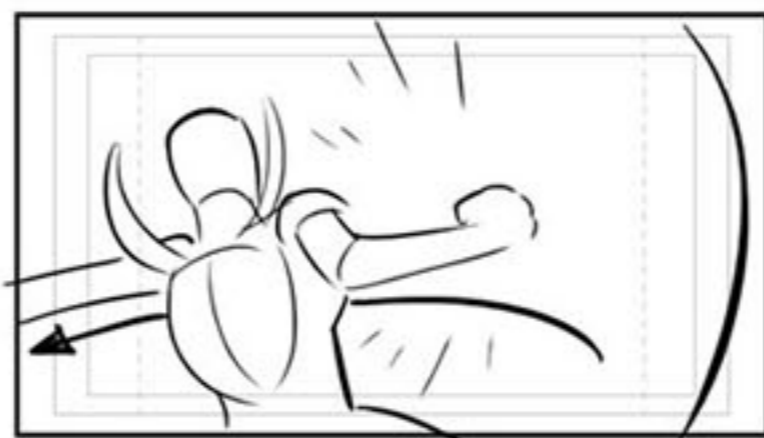
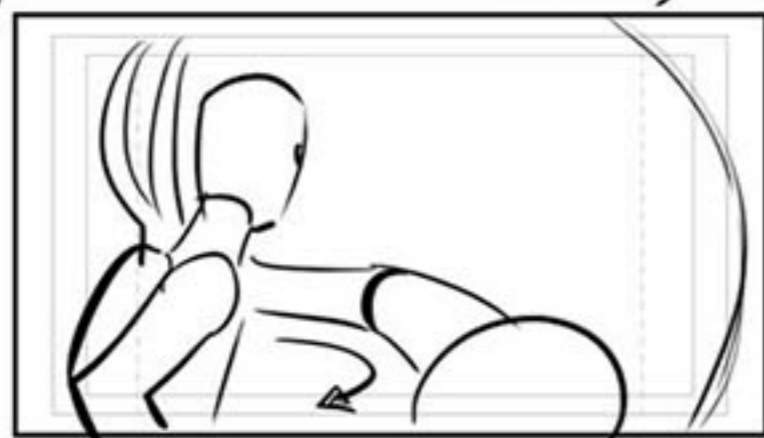

SLAM!

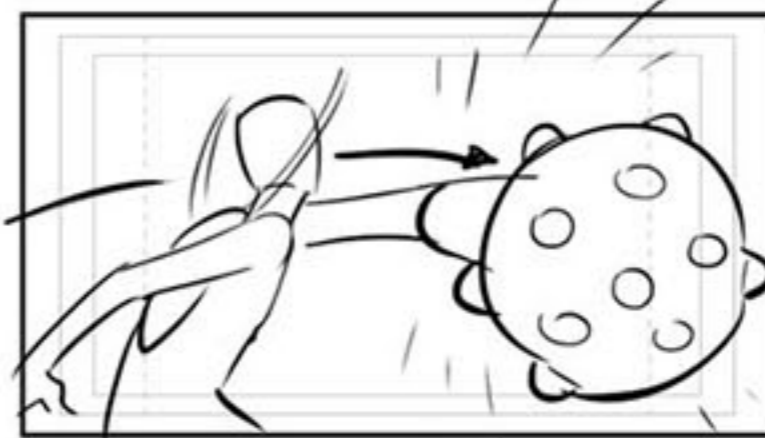

SLAM! Repeat

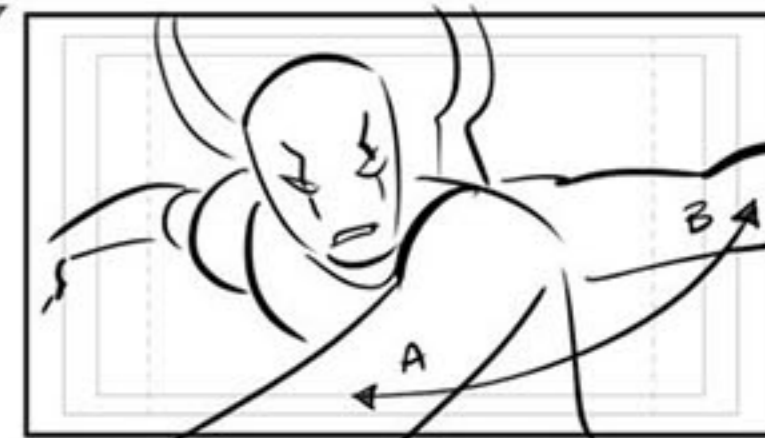

SLAM-SLAM-SLAM-Etc Analyze this containment field!

(90) AMB(VO): Scarab! Your attack is ineffective!

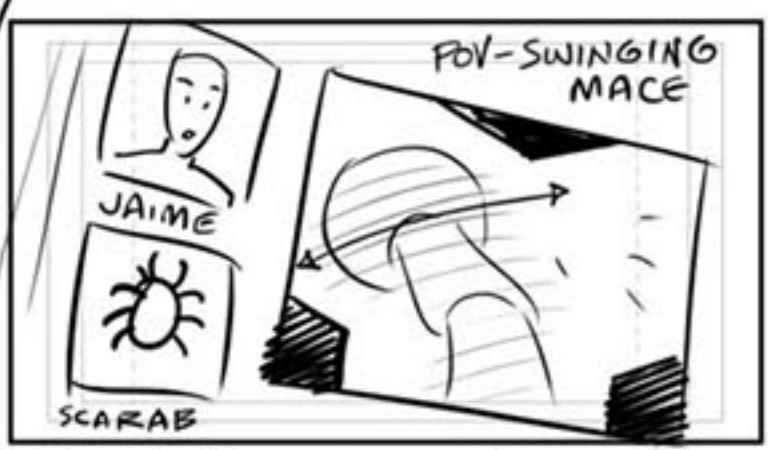

91 Sc (VO): Analysis already complete. Field displays energy signature -



-consistent with the alien "cooperative."



92 S: Cooperative technology draws power from kinetic energy.



The Scarab's physical attack is strengthening the force bubble.



It should know this!



93 AM: Scarab, do you have the means to effectively circumvent this tech?



94 Sc(VO): I do. A sonic attack would -



95 A: Don't explain it! Do it!



96 Z(OS): Eruces s'tekcor ecrof-elbbub htiw ym skeigam!



97 Z: I've reinforced Rocket's force bubble -

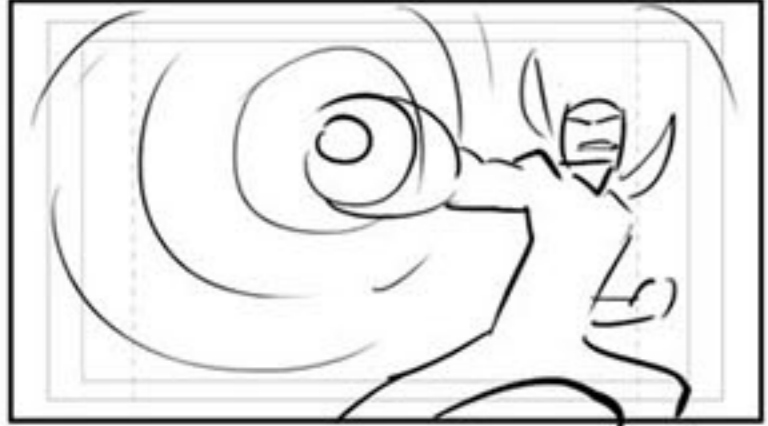

Sonics fire into bubble - fill it with sound waves

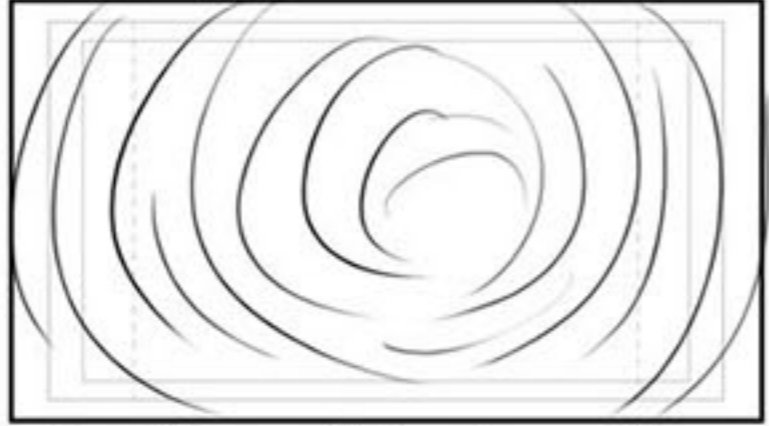

They dissipate

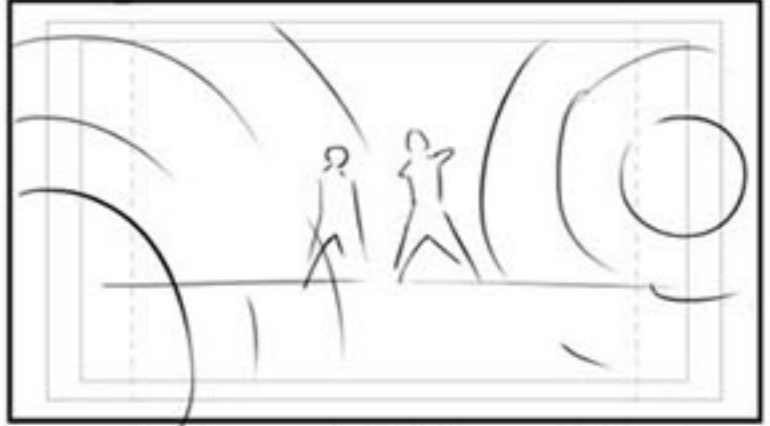

POV thru bubble - FX clear



to reveal R & Z



-with my magicks. Blue's not going anywhere.

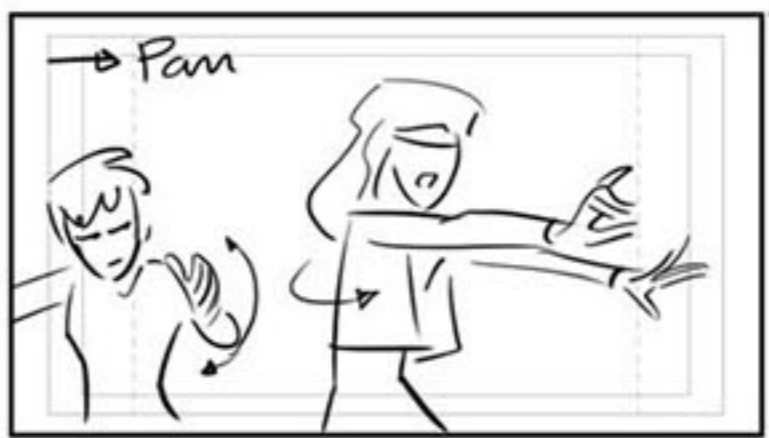

Eerf lrigtab dna eslupmi!



STAPLE DISSOLVES

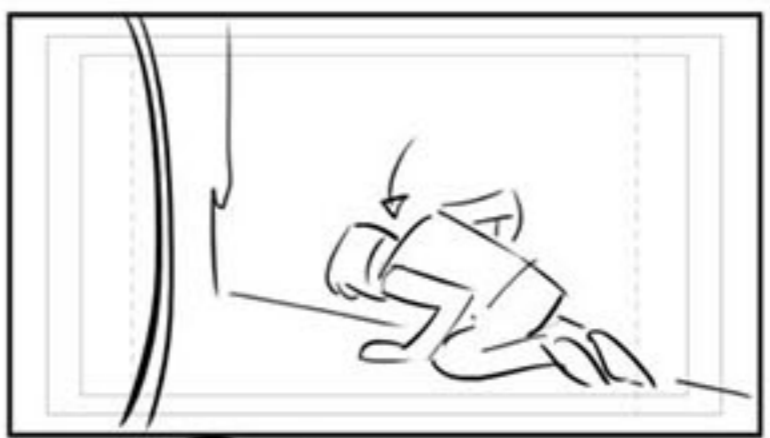

98 Walla



99 JR(VO): Ha! Don't you get it -

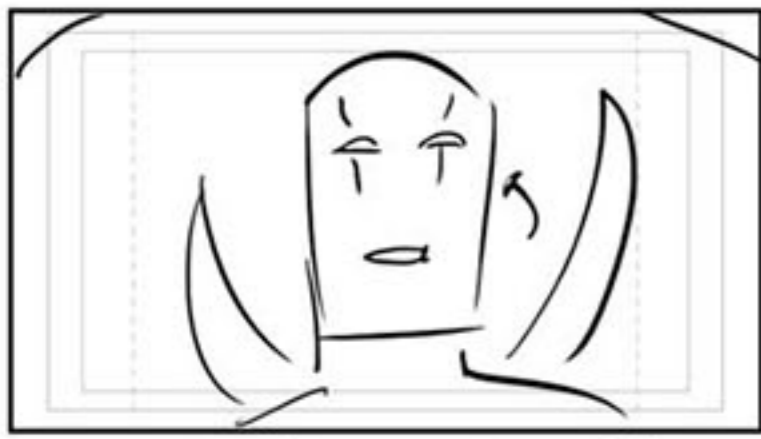

-extraterrestre?



Impulse and Batgirl were decoys! (98) Walla

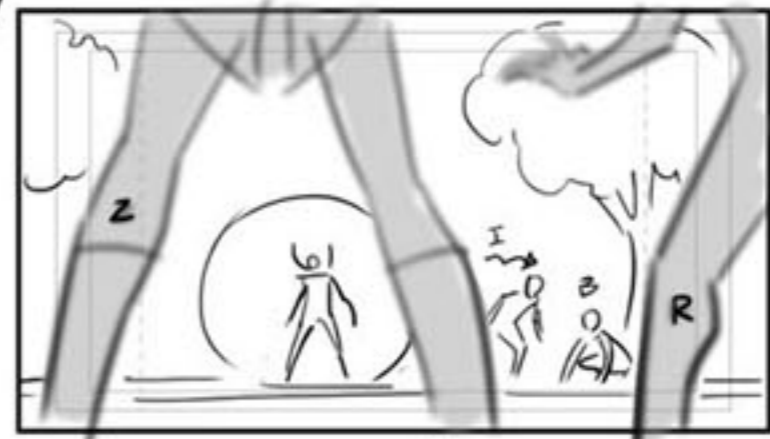

A distraction from-

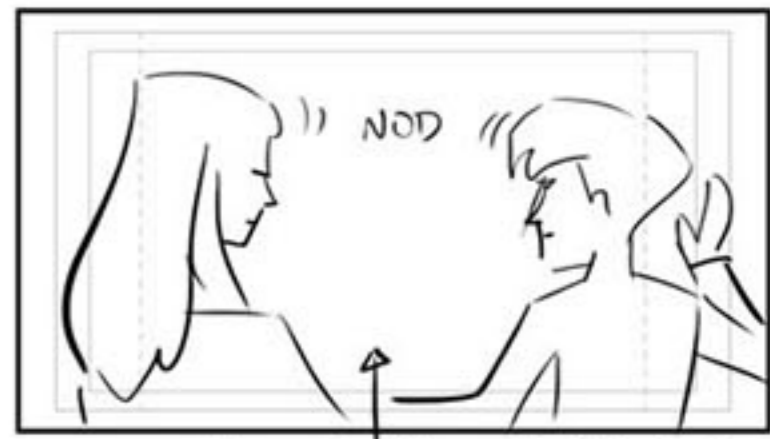

-Rocket & Zatanna's REAL attack.



(100) JR: Guess some first kills are harder than others!



(101) A: Scarab, proceed with countermeasures!



(102) Sc (VO): There are no known-

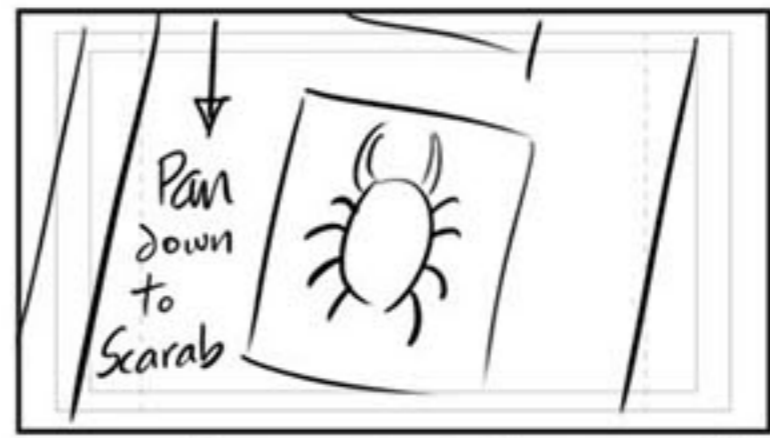

-countermeasures against this specific combination of magic and-



-cooperative technology.

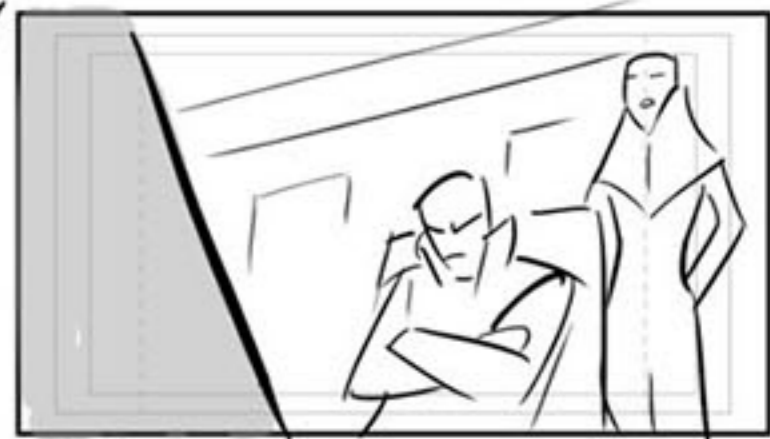
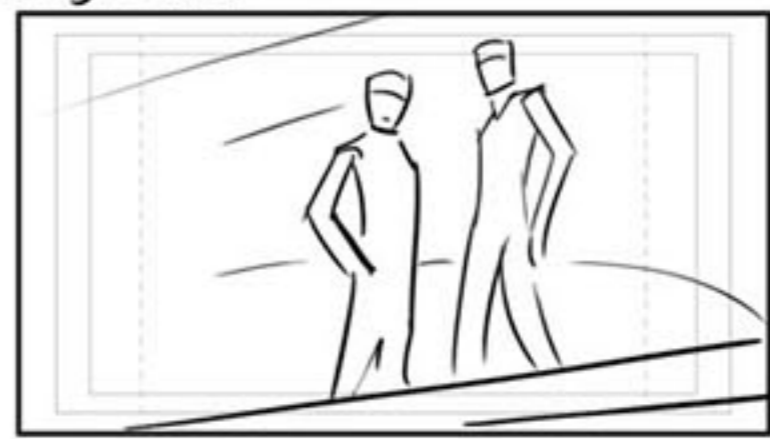
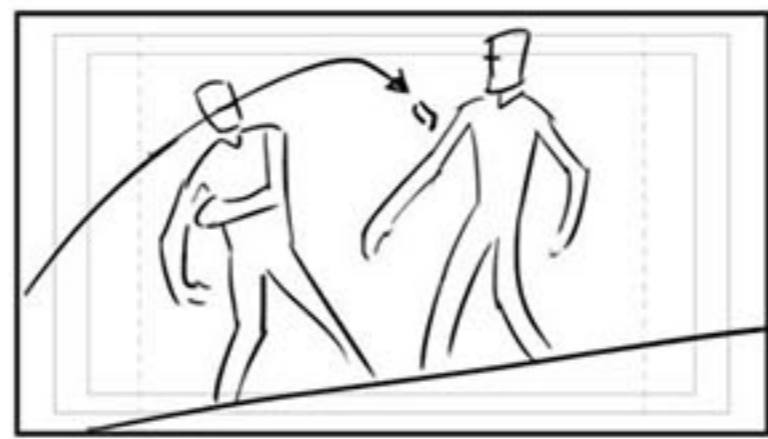
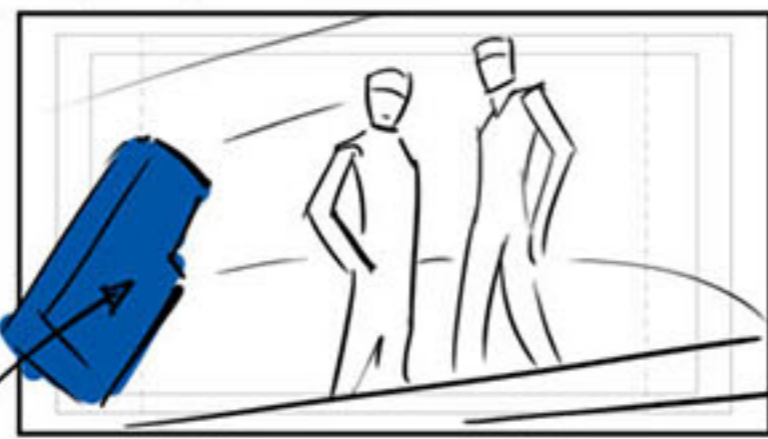

(103) S: This goes well.

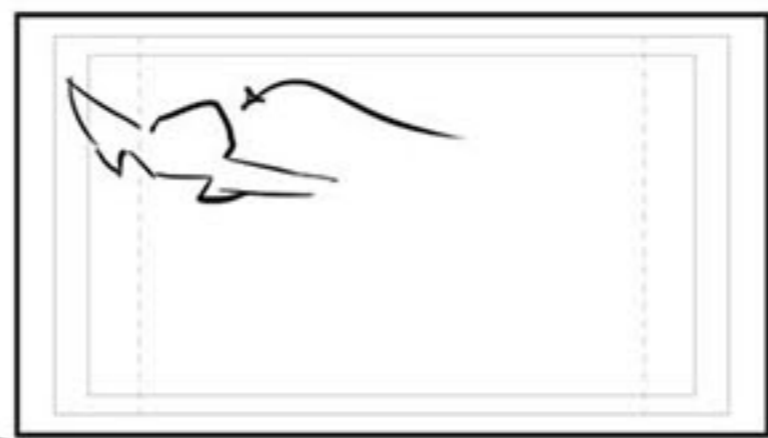
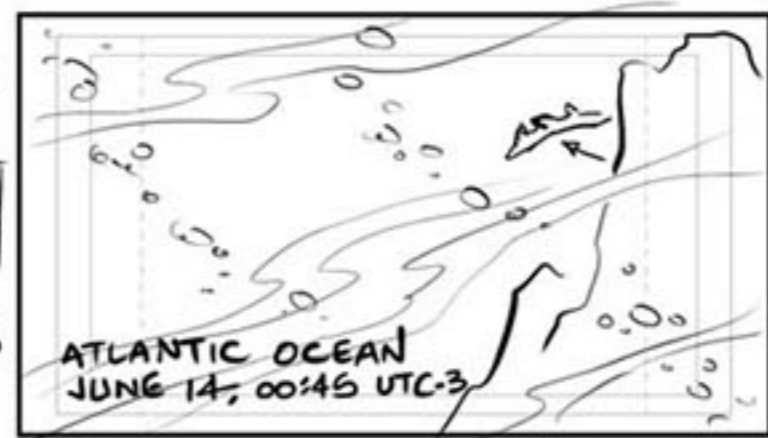
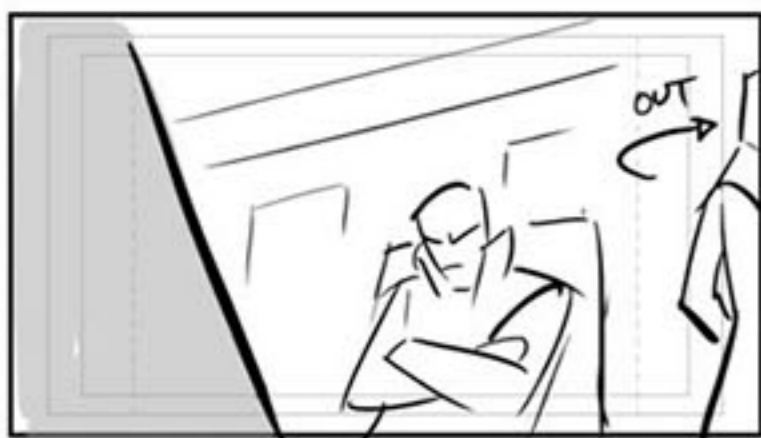

(104) MM: This isn't going well.



(105) MM: I'm sorry.



106 LB: YOU'RE sorry?



107 MM: la'gaan, try to understand.

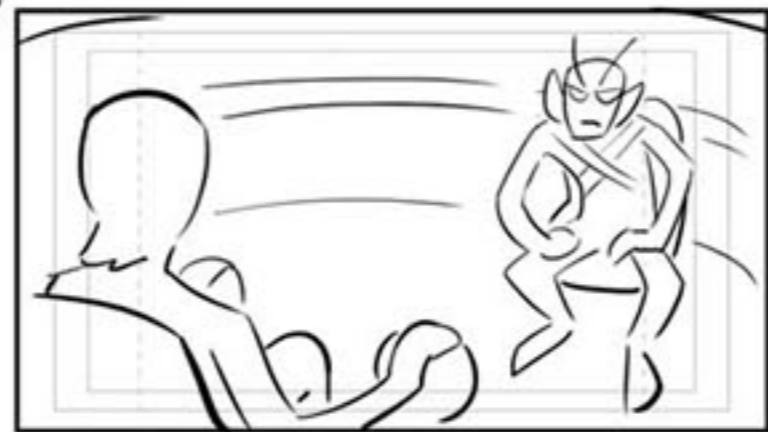

All those weeks in captivity gave me time to think -



- to gain clarity. I know now -



- I haven't been fair to you.



108 LB: Shouldn't I get to decide that?



109 MM: You don't see it yet.



But the hard truth is we only



got together because you made me feel better about myself.



And that's not a relationship.



It's selfishness.

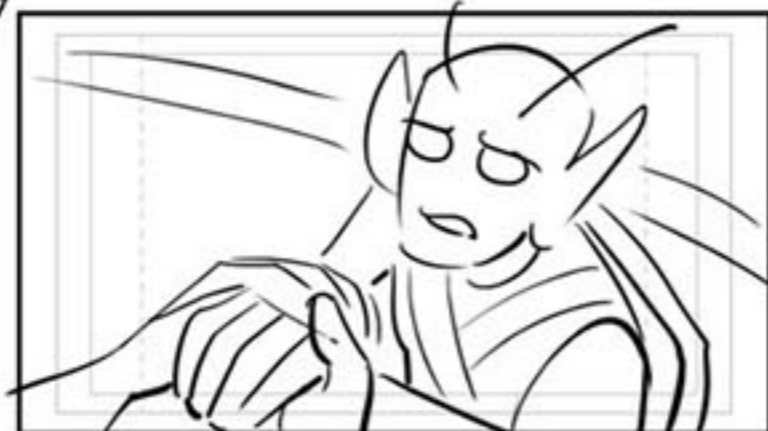

110 LB: That's just how it started, Angelfish! What matters -

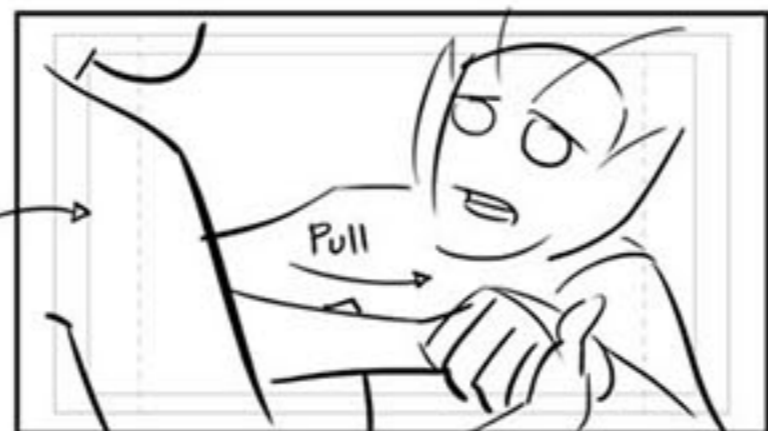

- is what it might become!



111 MM: Except that we'll never be any more to each other than what we are right now.

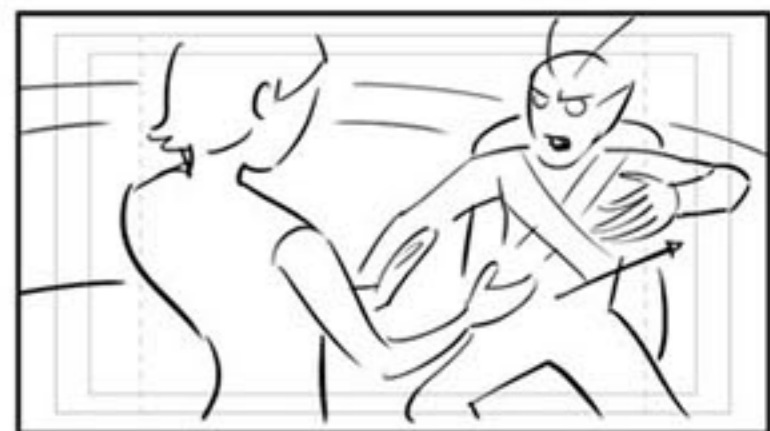

112 LB: Neptune's Beard! This is -



- about Conner, isn't it?



113 MM: No. It isn't about him.



Or you.



It's about me.



I can't give you what you want.



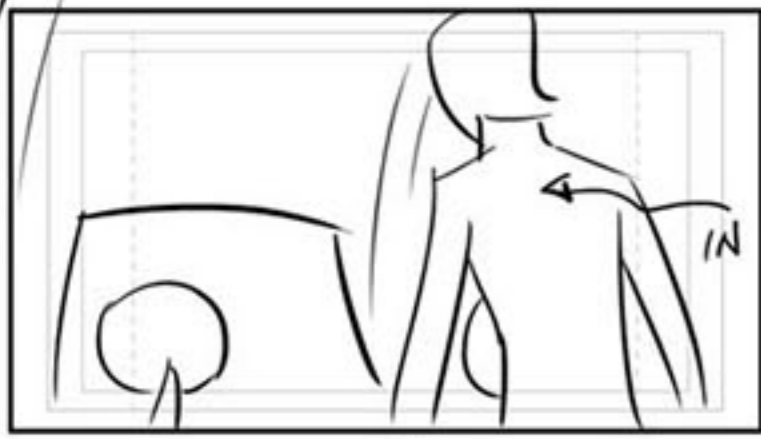

To be something other than my



-rebound guy. And you deserve

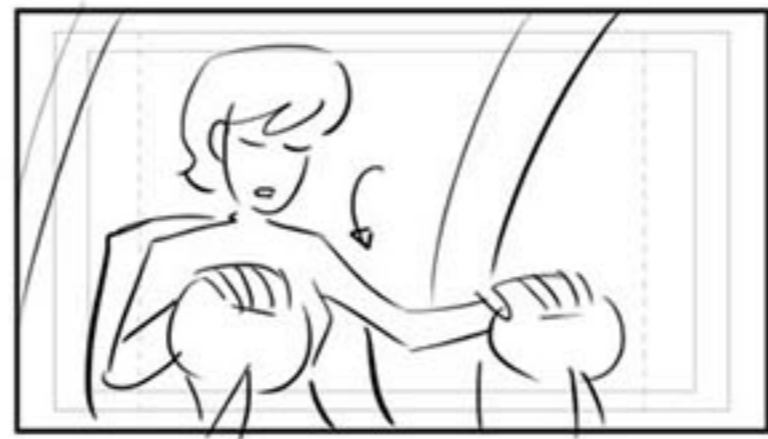

-more than that.



114 LB: You're right, M'gann.



I do.



glance up

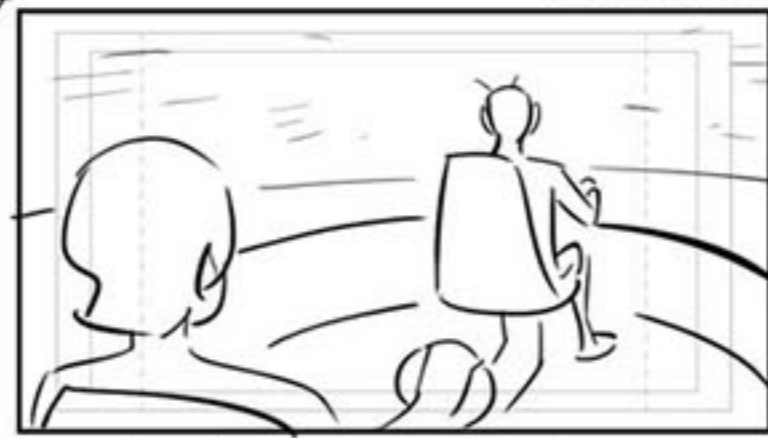

Hold for a long beat - like the entire rest of the show

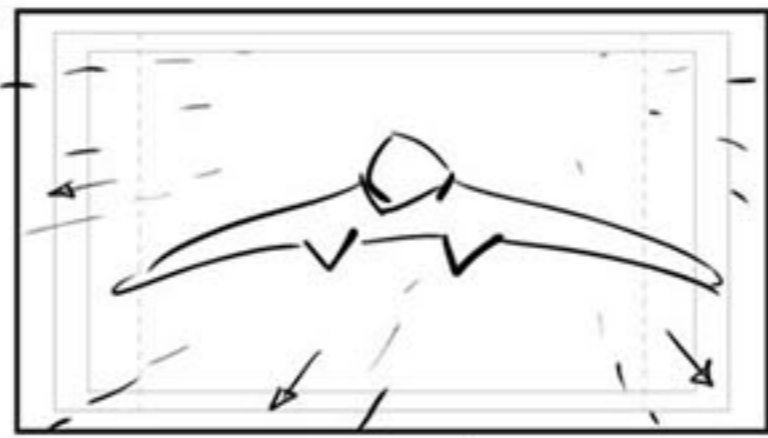

Go to ext



Pan up

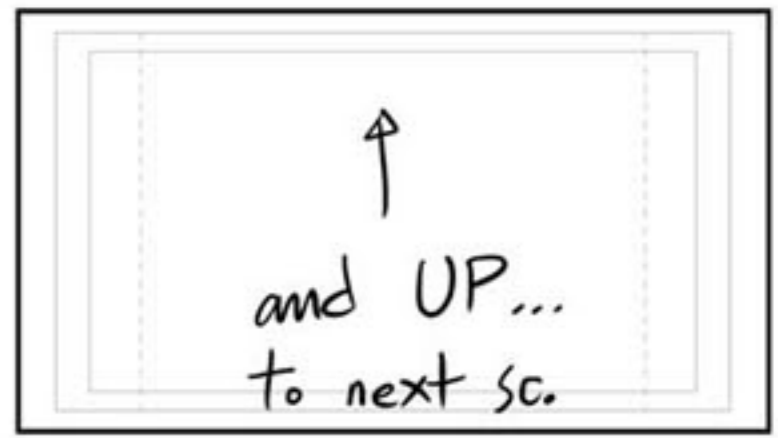

and UP... to next sc.

